

BAKER

....a passion for precision

PRICE LIST

EFFECTIVE 01-04-2026

BAKER GAUGES INDIA PRIVATE LIMITED

www.bakergauges.com



BMI DIVISION

CORPORATE OFFICE & FACTORY

33 - 1 - 2, NAGAR ROAD,
PUNE - 411 014. INDIA.



HIP DIVISION

HEAD OFFICE & FACTORY

37 - 40, NAGAR ROAD,
PUNE - 411 014. INDIA

AN ISO 9001:2015 CERTIFIED COMPANY

BAKER GAUGES INDIA PRIVATE LIMITED

CORPORATE OFFICE & FACTORY
33 - 1 - 2, NAGAR ROAD, PUNE - 411 014. INDIA.

BMI DIVISION



BAKER

...a passion for precision

BAKER BMI DIVISION PRICE LIST

Page Nos. 1 to 47

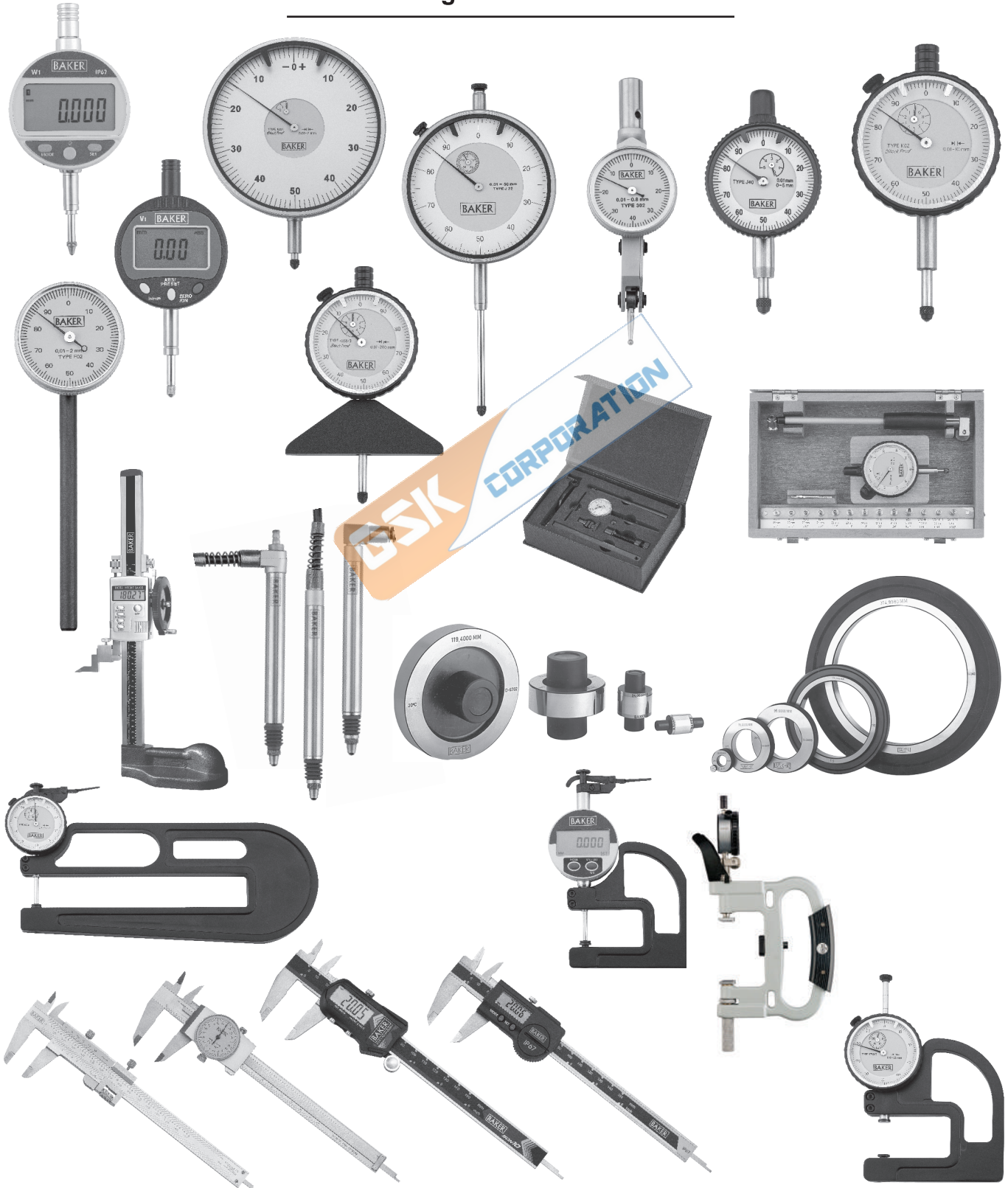

CERTIFICAT

CERTIFICADO

СЕРТИФИКАТ

認證證書

CERTIFICATE

ZERTIFIKAT



Management Service

CERTIFICATE

Certificate Registration No.: 12 100 7906 TMS / Order No.: 4153912057

The Certification Body
of TÜV SÜD Management Service GmbH

certifies that the organization

BAKER

...a passion for precision

**BAKER GAUGES INDIA PRIVATE LIMITED (BMI
DIVISION)**

33-1-2, NAGAR ROAD Pune – 411014, India

for the scope

**Design, Manufacturing and Supply of Precision Measuring Instruments,
Air Gauges, Electronic Gauges & Customized Gauging Solutions**

has established and applies a Quality Management System.

An audit was performed and has furnished proof
that the requirements according to

DIN EN ISO 9001:2015

are fulfilled.

The certificate is valid from **2024-02-07** until **2027-02-06**.

Fred Wenke
Head of Certification Body
Munich, 2024-02-06



DESCRIPTION	PAGE NO.
Plunger Type Dial Gauges	4
New IP67 Digital Dial Gauges (Plunger Type)	5
Digital Dial Gauge with Blue Tooth	5
Valueline Digital Dial Gauges (Plunger Type)	5 - 6
Tyre Tread Depth Gauges	6
Crankshaft Gauges	6
Precision Measuring Instruments Set	6
Hardness Tester Dial Gauges	6
Comparator Stand	6
Magnetic Stand	7
Universal Magnetic Stand	7
Std. Anvil Set for ID and OD measurement	7
Micrometer Stand	7
Dial Snap Gauges	7
Lever Type Dial Gauges	7 - 8
Back Plunger Dial Gauges	8
Universal Test Sets	8
Dial Bore Gauges	8 - 9
Dial Bore Gauges (Old Design - Shallow Type)	9
Bore Gauge Assembly (without Dial Gauge)	9 - 10
Digital Dial Bore Gauge	10
Dial Gauges for Bore Gauges	10
Dial Depth Gauges	11
Digital Dial Depth Gauges	11
Dial Thickness Gauges	11
Digital Dial Thickness Gauges	11
Dial Gauges and Instruments Accessories	12
Internal Groove Caliper Accessories	13
Height Gauge Accessories	13
Surface Roughness Tester Accessories	13
Dial Gauge Spares	14 - 26
Digital Calipers	27
Digital Depth Calipers	28
Vernier Depth Calipers	28
Dial Calipers	28
Vernier Calipers	28 - 29
Double Inside Groove Digital Caliper	29
Internal Dial Caliper IDC	29
Digital Height Gauges	30
Vernier Height Gauges	30
Double Column Digital Height Gauge	30
2D Height Gauges	31
Surface Roughness Tester SRT100	31
Universal Bevel Protractor	31
Precision Spirit Level	31
Slip Gauges - Steel and Carbide	31
Electronic Probes	32
Probes and Tools	32
NDT Products	32
Master Setting Rings	33
Carbide Master Setting Rings	34
Master Setting Discs	34
Terms & Conditions (for products)	34
Measuring Pin Sets	35
Calibration Charges For Master Setting Rings	36
Calibration Charges For Master Setting Discs / Plain Plug Gauges	36
Calibration Charges For Plain Taper Gauges (Male / Female)	36
Calibration Charges For Roundness Measurement (Internal & External Diameter)	37
Calibration Charges For Roundness Masters	37
Calibration Charges For Surface Finish Measurement / Roughness Masters	37
Calibration Charges For Dial Gauges	37
Calibration Charges For Electronic Products	37
Calibration Charges For Digital Dial Gauges	37
Calibration Charges For Digital Calipers / Dial Calipers / Vernier Calipers	37
Calibration Charges For Height Gauges	38
Calibration Charges For Three Point Micrometers	38
Calibration Charges For Slip Gauges	38
Terms & Conditions (for services)	38
Calibration Services	39
NABL Certificate of Accreditation	40
NABL Scope of Accreditation	41-47

PLUNGER TYPE DIAL GAUGES (MODEL 40)

PRODUCT CODE	TYPE	READING	RANGE	GRADUATION	UNIT RATE ₹
D01469000	K39	0.01 mm	5.0 mm	0-50-0	2,690.00
D01459000	K40	0.01 mm	5.0 mm	0-100	2,690.00
D06259000	K35	0.1 mm	10 mm	0-10	3,110.00
D01349000	K40Z	0.01 mm	0.8 mm	0-40-0	2,980.00
D01319000	K36	0.01 mm	5.0 mm	0-50	3,370.00
D11139000	K41	0.001 inch	0.25 inch	0-50-0	2,970.00
D11129000	K42	0.001 inch	0.25 inch	0-100	2,970.00
D05519000	K43	0.0005 inch	0.25 inch	0-50	3,260.00

PLUNGER TYPE DIAL GAUGES (MODEL 56)

PRODUCT CODE	TYPE	READING	RANGE	GRADUATION	UNIT RATE ₹
D01399000	KZ	0.01 mm	0.8 mm	40-0-40	1,910.00
D01359000	KO1	0.01 mm	10.0 mm	0-50-0	1,730.00
D01099000	KO2	0.01 mm	10.0 mm	0-100	1,750.00
D01369000	KO3	0.01 mm	5.0 mm	0-50-0	1,790.00
D01379000	KO4	0.01 mm	5.0 mm	0-100	1,790.00
D06139000	KO5SP	0.1 mm	10.0 mm	0-10	1,700.00
D06159000	KO6A	0.1 mm	25.0 mm	0-10	2,380.00
D01479000	KO8A	0.01 mm	25.0 mm	0-100	2,220.00
D01389000	KO8	0.01 mm	25.0 mm	0-100	2,380.00
D01429000	KO7	0.01 mm	30.0 mm	0-100	3,770.00
D23129000	KO9	0.002 mm	2.0 mm	0-10-0	3,770.00
D23139000	K10	0.002 mm	2.0 mm	0-20	3,770.00
D23149000	K11	0.002 mm	5.0 mm	0-10-0	3,930.00
D23119000	K12	0.002 mm	5.0 mm	0-20	3,180.00
D23309000	K13A	0.002 mm	12.0 mm	0-10-0	7,270.00
D23319000	K14A	0.002 mm	12.0 mm	0-20	7,270.00
D28089000	K17S	0.001 mm	1.0 mm	0-100-0	3,800.00
D01279000	K20	0.010 mm	50.0 mm	0-100	6,200.00
D11119000	KY	0.001 inch	0.08 inch	40-0-40	2,070.00
D11099000	K51	0.001 inch	0.5 inch	0-50-0	2,490.00
D11109000	K52	0.001 inch	0.5 inch	0-100	2,490.00
D11089000	K50	0.001 inch	1.0 inch	0-100	3,270.00
D16059000	K53	0.0005 inch	0.5 inch	0-25-0	3,040.00
D16069000	K54	0.0005 inch	0.5 inch	0-50	3,040.00
D25099000	K61	0.0001 inch	0.2 inch	0-50-0	5,460.00
D25109000	K62	0.0001 inch	0.2 inch	0-100	5,460.00
D25159000	K63A	0.0001 inch	0.5 inch	0-50-0	8,800.00
D25169000	K64A	0.0001 inch	0.5 inch	0-100	8,800.00
D11179000	K21	0.001 inch	2.0 inch	0-100	6,200.00

PLUNGER TYPE DIAL GAUGES (MODEL 88)

PRODUCT CODE	TYPE	READING	RANGE	GRADUATION	UNIT RATE ₹
D01269000	K72	0.01 mm	50.0 mm	0-100	7,860.00
D11149000	K76	0.001 inch	2.0 inch	0-100	8,310.00

PLUNGER TYPE DIAL GAUGES (0-100mm)

PRODUCT CODE	TYPE	READING	RANGE	GRADUATION	UNIT RATE ₹
D05509000	K100	0.01 mm	100 mm	0-100	25,230.00

PLUNGER TYPE DIAL GAUGES (MODEL 105)

PRODUCT CODE	TYPE	READING	RANGE	GRADUATION	UNIT RATE ₹
D01409000	K101	0.01 mm	2.0 mm	0-50-0	7,090.00

DIAL GAUGES & INSTRUMENTS



NEW IP67 DIGITAL DIAL GAUGES (PLUNGER TYPE)

PRODUCT CODE	DESCRIPTION	UNIT RATE ₹
E61089000	BAKER Water Resistant Digital Dial Gauge, Type W1 with metric & inch capability & RS232 data output, conforming to IP67. Reading : 0.001 mm / 0.00005 inch Range : 12.5 mm / 0.5 inch	29,910.00
E61099000	BAKER Water Resistant Digital Dial Gauge, Type W2 with metric & inch capability & RS232 data output, conforming to IP67. Reading : 0.001 mm / 0.00005 inch Range : 25 mm / 1.0 inch	31,420.00
E61189000	BAKER Water Resistant Digital Dial Gauge, Type W3 with metric & inch capability & RS232 data output, conforming to IP67. Reading : 0.001 mm / 0.00005 inch Range : 50 mm / 2.0 inch	53,940.00
E61199000	BAKER Water Resistant Digital Dial Gauge, Type W1A (with advance features) with metric & inch capability & RS232 data output, conforming to IP67. Reading : 0.001 mm / 0.00005 inch Range : 12.5 mm / 0.5 inch	31,810.00
E61299000	BAKER Water Resistant Digital Dial Gauge, Type W2A (with advance features) with metric & inch capability & RS232 data output, conforming to IP67. Reading : 0.001 mm / 0.00005 inch Range : 25 mm / 1.0 inch	33,210.00
E61179000	BAKER Water Resistant Digital Dial Gauge, Type W3A (with advance features) with metric & inch capability & RS232 data output, conforming to IP67. Reading : 0.001 mm / 0.00005 inch Range : 50 mm / 2.0 inch	55,770.00
E61149000	BAKER Water Resistant Digital Dial Gauge with Blue Tooth Type W1A-B with metric and inch capability & RS232 data output, conforming to IP67. Reading : 0.001 mm / 0.00005 inch Range : 12.5 mm / 0.5 inch	39,680.00
E61159000	BAKER Water Resistant Digital Dial Gauge with Blue Tooth Type W2A-B with metric and inch capability & RS232 data output, conforming to IP67. Reading : 0.001 mm / 0.00005 inch Range : 25 mm / 1.0 inch	43,130.00
XE62211005	BAKER Proximity Cable for RS232 interface suitable for W1, W2, W3, W1A, W2A & W3A Digital Dial Gauges.	9,090.00
XE62211004	BAKER Proximity Cable for USB interface suitable for W1, W2, W3, W1A, W2A & W3A Digital Dial Gauges.	9,920.00
E61081028	Lugback with screws for W1, W2, W3, W1A, W2A & W3A Digital Dial Gauges	1,110.00

VALUELINE DIGITAL DIAL GAUGES (PLUNGER TYPE)

PRODUCT CODE	DESCRIPTION	UNIT RATE ₹
E61109000	BAKER Digital Dial Gauge, Type V1 with metric & inch capability Reading : 0.01 mm / 0.0005 inch Range : 12.5 mm / 0.5 inch	8,050.00
E61119000	BAKER Digital Dial Gauge, Type V2 with metric & inch capability Reading : 0.01 mm / 0.0005 inch Range : 25 mm / 1.0 inch	9,490.00
E61129000	BAKER Digital Dial Gauge, Type V3 with metric & inch capability Reading : 0.01 mm / 0.0005 inch Range : 50 mm / 2.0 inch	23,280.00

VALUELINE DIGITAL DIAL GAUGES (PLUNGER TYPE)

PRODUCT CODE	DESCRIPTION	UNIT RATE ₹
E61209000	BAKER Digital Dial Gauge, Type V1P with metric & inch capability Reading : 0.001 mm / 0.00005 inch Range : 12.5 mm / 0.5 inch	15,800.00
E61219000	BAKER Digital Dial Gauge, Type V2P with metric & inch capability Reading : 0.001 mm / 0.00005 inch Range : 25 mm / 1.0 inch	18,980.00
E61101009	Lugback for V1, V2, V3, V1P, V2P Digital Dial Gauges	930.00

TYRE TREAD DEPTH GAUGES

PRODUCT CODE	TYPE	READING	RANGE	GRADUATION	UNIT RATE ₹
D06579000	TTG01	0.1 mm	8.0 mm	-	2,180.00
D06599000	TTG02	0.004 inch	0.32 inch	-	2,400.00

CRANKSHAFT GAUGES

D45579000	CS1	0.01 mm	60 - 600 mm	0-50	8,020.00
D45589000	CS2	0.0005 inch	2.4 - 23.6 inch	0-20	8,810.00

PRECISION MEASURING INSTRUMENTS SET

D01579000	PMI-3	Set consisting of BAKER Digital Caliper SDN10, Dial Gauge KO2 & Micrometer MMC25		8,700.00
-----------	-------	---	--	----------

HARDNESS TESTER DIAL GAUGES

PRODUCT CODE	DESCRIPTION	UNIT RATE ₹
D04329000	BAKER Hardness Tester Dial Gauge (Rockwell) Standard	3,430.00

COMPARATOR STAND

D82029000	BAKER Comparator Stand Plain Base - Type CS150 Gauging Height : 150mm	8,530.00
D82009000	BAKER Comparator Stand Plain Base - Type CS 200 Gauging Height : 200 mm	10,160.00
D82039000	BAKER Comparator Stand Serrated Base Type CS-150-S (SIZE : 90X95) Gauging Height : 150mm	8,850.00
D82019000	BAKER Comparator Stand Serrated Base Type CS-200-S (SIZE : 150X100) Gauging Height : 200mm	10,810.00

DIAL GAUGES & INSTRUMENTS

MAGNETIC STAND

D83019000	BAKER Magnetic Stand - Type MS	1,660.00
D83029000	BAKER Magnetic Stand with Fine Adjustment - Type MSF	1,770.00
D83059000	BAKER Universal Magnetic Stand - Type UMS	3,490.00

STANDARD ANVIL SET

D93001000	Standard Anvil Set for ID & OD Measurement	8,250.00
-----------	---	----------

MICROMETER STAND

M03179000	Micrometer Stand BMS 100	1,150.00
-----------	---------------------------------	----------

DIAL SNAP GAUGES

PRODUCT CODE	DESCRIPTION	UNIT RATE ₹
-	BAKER Type DS25 Dial Snap Gauge (without Dial Gauge) Range : 0 - 25 mm	9050.00
-	BAKER Type DS50 Dial Snap Gauge (without Dial Gauge) Range : 25 - 50 mm	9350.00
-	BAKER Type DS75 Dial Snap Gauge (without Dial Gauge) Range : 50 - 75 mm	10660.00
-	BAKER Type DS100 Dial Snap Gauge (without Dial Gauge) Range : 75 - 100 mm	11180.00
-	BAKER Type DS125 Dial Snap Gauge (without Dial Gauge) Range : 100 - 125 mm	13000.00
-	BAKER Type DS150 Dial Snap Gauge (without Dial Gauge) Range : 125 - 150 mm	14280.00
-	BAKER Type DS175 Dial Snap Gauge (without Dial Gauge) Range : 150 - 175 mm	14760.00
-	BAKER Type DS200 Dial Snap Gauge (without Dial Gauge) Range : 175 - 200 mm	16030.00
-	BAKER Type DS225 Dial Snap Gauge (without Dial Gauge) Range : 200 - 225 mm	19510.00
-	BAKER Type DS250 Dial Snap Gauge (without Dial Gauge) Range : 225 - 250 mm	22360.00
-	BAKER Type DS275 Dial Snap Gauge (without Dial Gauge) Range : 250 - 275 mm	27230.00
-	BAKER Type DS300 Dial Snap Gauge (without Dial Gauge) Range : 275 - 300 mm	30480.00

LEVER TYPE DIAL GAUGES (MODEL 29)

PRODUCT CODE	TYPE	READING	RANGE	GRADUATION	UNIT RATE ₹
D30259000	302P	0.01 mm	0.8 mm	0-40-0	4,910.00
D34009000	304	0.002 mm	0.2 mm	0-10-0	5,990.00
D32009000	301	0.0005 inch	0.03 inch	0-15-0	6,260.00
D35009000	303	0.0001 inch	0.008 inch	0-4-0	9,140.00

Supplied with 2mm Ø T.C. Ball Stylus fitted to the gauge and 1mm Ø T.C. Ball Stylus, Height Gauge Adaptor, Ø 4mm & 8mm Dovetail Spigot Assembly and Universal Clamp as standard accessories in a box.

D30289000	302AP	0.01 mm	0.8 mm	0-40-0	4,280.00
D34509000	304A	0.002 mm	0.2 mm	0-10-0	4,630.00
D32519000	301A	0.0005 inch	0.03 inch	0-15-0	5,440.00
D35519000	303A	0.0001 inch	0.008 inch	0-4-0	8,370.00

Supplied with 2mm Ø T.C. Ball Stylus & 8mm Dovetail Spigot Assembly fitted to the gauge.

LEVER TYPE DIAL GAUGES WITH LONG STYLUS (MODEL 29)

PRODUCT CODE	TYPE	READING	RANGE	GRADUATION	UNIT RATE ₹
D30039000	302L	0.01 mm	0.8 mm	0-40-0	7,000.00
D32039000	301L	0.0005 inch	0.03 inch	0-15-0	8,210.00

Supplied with 33mm long 2mm Ø T.C. Ball Stylus fitted to the gauge, Height Gauge Adaptor, Ø 4mm & 8mm Dovetail Spigot Assembly and Universal Clamp as standard accessories in a box.

D30519000	302AL	0.01 mm	0.8 mm	0-40-0	6,090.00
D33009000	301AL	0.0005 inch	0.03 inch	0-15-0	6,990.00

Supplied with 33mm long 2mm Ø T.C. Ball Stylus & 8mm Dovetail Spigot Assembly fitted to the Gauge.

LEVER TYPE DIAL GAUGES (MODEL 38)

PRODUCT CODE	TYPE	READING	RANGE	GRADUATION	UNIT RATE ₹
D30279000	306P	0.01 mm	0.8 mm	0-40-0	5,720.00
D34029000	308	0.002 mm	0.2 mm	0-10-0	7,040.00
D32029000	305	0.0005 inch	0.03 inch	0-15-0	7,420.00
D35029000	307	0.0001 inch	0.008 inch	0-4-0	9,870.00

Supplied with 2mm Ø T.C. Ball Stylus fitted to the gauge and 1mm Ø T.C. Ball Stylus, Height Gauge Adaptor, Ø 4mm & 8mm Dovetail Spigot Assembly and Universal Clamp as standard accessories in a box.

D30299000	306AP	0.01 mm	0.8 mm	0-40-0	4,450.00
D34519000	308A	0.002 mm	0.2 mm	0-10-0	6,020.00
D32529000	305A	0.0005 inch	0.03 inch	0-15-0	6,460.00
D35539000	307A	0.0001 inch	0.008 inch	0-4-0	9,030.00

Supplied with 2mm dia. T.C. Ball Stylus & 8mm Dovetail Spigot Assembly fitted to the gauge.

LEVER TYPE DIAL GAUGES WITH LONG STYLUS (MODEL 38)

PRODUCT CODE	TYPE	READING	RANGE	GRADUATION	UNIT RATE ₹
D30049000	306L	0.01 mm	0.8 mm	0-40-0	7,660.00
D32049000	305L	0.0005 inch	0.03 inch	0-15-0	9,000.00

Supplied with 33mm long 2mm Ø T.C. Ball Stylus fitted to the gauge, Height Gauge Adaptor, Ø 4mm & 8mm Dovetail Spigot Assembly and Universal Clamp as standard accessories in a box.

D30599000	306AL	0.01 mm	0.8 mm	0-40-0	6,740.00
D32549000	305AL	0.0005 inch	0.03 inch	0-15-0	7,640.00

Supplied with 33mm long 2mm Ø T.C. Ball Stylus & 8mm Dovetail Spigot Assembly fitted to the Gauge.

BACK PLUNGER DIAL GAUGES (MODEL 38)

D40019000	FO1	0.01 mm	2.0 mm	0-50-0	2,630.00
D40009000	FO2	0.01 mm	2.0 mm	0-100	2,630.00
D42019000	F51	0.001 inch	0.1 inch	0-50-0	2,950.00
D42009000	F52	0.001 inch	0.1 inch	0-100	2,950.00

UNIVERSAL TEST SETS

D46019000	UI01	0.01 mm	2.0 mm	0-50-0	4,320.00
D46009000	UI02	0.01 mm	2.0 mm	0-100	4,320.00
D47019000	UI51	0.001 inch	0.1 inch	0-50-0	4,750.00
D47009000	UI52	0.001 inch	0.1 inch	0-100	4,750.00

DIAL BORE GAUGES

Range 4 - 6 mm (0.160"- 0.236")

PRODUCT CODE	TYPE	READING	BORE DEPTH	GRADUATION	UNIT RATE ₹
D71009000	K439	0.01 mm	35 mm	0-50-0	27,430.00

Range 6 - 10 mm (0.236"- 0.4")

D72019000	K539	0.01 mm	48 mm	0-50-0	14,360.00
-----------	------	---------	-------	--------	-----------

DIAL GAUGES & INSTRUMENTS

Range 10 - 18 mm (0.4" - 0.7")

PRODUCT CODE	TYPE	READING	BORE DEPTH	GRADUATION	UNIT RATE ₹
D77039000	K639	0.01 mm	100 mm	0-50-0	9,510.00
D77049000	K641	0.001 inch	4 inch	0-50-0	9,730.00

Range 18 - 50 mm (0.7" - 2")

D73059000	K703	0.01 mm	150 mm	0-50-0	8,690.00
D73069000	K709	0.002 mm	150 mm	0-10-0	10,490.00
D73119000	K717	0.001 mm	150 mm	0-100-0	10,770.00
D73079000	K753	0.0005 inch	6 inch	0-25-0	9,920.00
D73089000	K761	0.0001 inch	6 inch	0-50-0	11,180.00

Range 50 - 150 mm (2" - 6")

D75149000	K803	0.01 mm	150 mm	0-50-0	9,220.00
D75069000	K809	0.002 mm	150 mm	0-10-0	10,920.00
D75129000	K817	0.001 mm	150 mm	0-100-0	11,170.00
D75079000	K853	0.0005 inch	6 inch	0-25-0	10,830.00
D75089000	K861	0.0001 inch	6 inch	0-50-0	12,070.00

DIAL BORE GAUGES (OLD DESIGN - SHALLOW TYPE)

Range: 50 - 150 mm (2" - 6")

D75059000	K803S	0.01 mm	250 mm	0-50-0	10,460.00
D75059000	K809S	0.002 mm	250 mm	0-10-0	12,400.00
D75039000	K853S	0.0005"	10 inch	0-25-0	11,760.00
D75049000	K861S	0.0001"	10 inch	0-50-0	13,710.00

DIAL BORE GAUGES

Range 150 - 250 mm (6" - 10")

D78019000	K903	0.01 mm	150 mm	0-50-0	16,630.00
D78029000	K909	0.002 mm	150 mm	0-10-0	18,050.00
D78039000	K917	0.001 mm	150 mm	0-100-0	18,430.00
D78049000	K953	0.0005"	6 inch	0-25-0	17,350.00
D78059000	K961	0.0001"	6 inch	0-50-0	18,120.00

Range 250 - 450 mm (10" - 18")

D79019000	K1003	0.01 mm	250mm	0-50-0	20,750.00
D79029000	K1009	0.002 mm	250mm	0-10-0	22,330.00
D79039000	K1017	0.001 mm	250mm	0-100-0	22,730.00
D79049000	K1053	0.0005"	10 inch	0-25-0	21,550.00
D79059000	K1061	0.0001"	10 inch	0-50-0	23,250.00

BORE GAUGE ASSEMBLY (WITHOUT DIAL GAUGE)

Range: 4 - 6 mm (0.160" - 0.236")

PRODUCT CODE	DESCRIPTION	UNIT RATE ₹
D71009000	BAKER Bore Gauge Assembly (Without Dial Gauge)	23,450.00

Range: 6 - 10 mm (0.236" - 0.4")

D72009000	BAKER Bore Gauge Assembly (Without Dial Gauge)	11,130.00
-----------	--	-----------

Range: 10 - 18 mm (0.4" - 0.7")

D77009000	BAKER Bore Gauge Assembly (Without Dial Gauge)	6,470.00
-----------	--	----------

Range: 18 - 50 mm (0.7" - 2")

D73809000	BAKER Bore Gauge Assembly (Without Dial Gauge)	7,670.00
-----------	--	----------

Range: 50 - 150 mm (2" - 6")

D75009000	BAKER Bore Gauge Assembly (Without Dial Gauge)	8,690.00
-----------	--	----------

BORE GAUGE ASSEMBLY OLD DESIGN SHALLOW TYPE (WITHOUT DIAL GAUGE)
Range: 50 - 150 mm (2" - 6")

PRODUCT CODE	DESCRIPTION	UNIT RATE ₹
D75009000	BAKER Bore Gauge Assembly (Without Dial Gauge)	9,370.00

BORE GAUGE ASSEMBLY (WITHOUT DIAL GAUGE)
Range: 150 - 250 mm (6" - 10")

PRODUCT CODE	DESCRIPTION	UNIT RATE ₹
D78009000	BAKER Bore Gauge Assembly (Without Dial Gauge)	15,450.00

Range: 250 - 450 mm (10" - 18")

PRODUCT CODE	DESCRIPTION	UNIT RATE ₹
D79009000	BAKER Bore Gauge Assembly (Without Dial Gauge)	19,750.00

DIGITAL DIAL BORE GAUGES
Range: 10 - 18 mm (0.4" - 0.7")

PRODUCT CODE	TYPE	READING	BORE DEPTH	UNIT RATE ₹
D77059000	K60/D	0.01 mm / 0.0005 inch	100 mm	16,120.00

Range: 18 - 50 mm (0.7" - 2")

D73099000	K70/D	0.01 mm / 0.0005 inch	150 mm	16,770.00
D73109000	K70/DP	0.001 mm / 0.00005 inch	150 mm	21,880.00

Range: 50 - 150 mm (2" - 6")

D75099000	K80/D	0.01 mm / 0.0005 inch	150 mm	17,100.00
D75159000	K80/DP	0.001 mm / 0.00005 inch	150 mm	21,900.00

DIGITAL DIAL BORE GAUGES (OLD DESIGN - SHALLOW TYPE)
Range: 50 - 150 mm (2" - 6")

-	K80DS	0.01 mm/0.0005 inch	250 mm	18,210.00
-	K80DPS	0.001 mm/0.00005 inch	250 mm	25,250.00

DIGITAL DIAL BORE GAUGES
Range 150-250 mm (6" - 10")

D78069000	K90/D	0.01 mm/0.0005 inch	250 mm	27,700.00
D78079000	K90/DP	0.001 mm/0.00005 inch	250 mm	33,900.00

Range 250-450 mm (10" - 17")

D79069000	K10/D	0.01 mm/0.0005 inch	250 mm	32,880.00
D79079000	K10/DP	0.001 mm/0.00005 inch	250 mm	39,090.00
D75759000	200 mm Bore Gauge Depth Extension (50-150 mm)			1,430.00

DIAL GAUGES FOR BORE GAUGES

Part No	Description	Reading	Unite Rate ₹
D02919000	Dial Gauge for Bore Guage BGD-10	0.010 mm	1,740.00
D23269000	Dial Gauge for Bore Guage BGD-2	0.002 mm	3,650.00
D28099000	Dial Gauge for Bore Guage BGD-1	0.001 mm	3,540.00
D16079000	Dial Gauge for Bore Guage BGD-0.0005"	0.0005"	2,950.00
D25179000	Dial Gauge for Bore Guage BGD-0.0001"	0.0001"	5,290.00

DIAL GAUGES & INSTRUMENTS

DIAL DEPTH GAUGES

PRODUCT CODE	TYPE	READING	RANGE	GRADUATION	UNIT RATE ₹
D50019000	K158/0	0.1 mm	0-200 mm	10-0	3,350.00
D51049000	K158/3	0.01 mm	0-200 mm	100-0	3,800.00
D52039000	K158/1	0.001 inch	0-8 inch	100-0	4,180.00

DIGITAL DIAL DEPTH GAUGES

PRODUCT CODE	TYPE	READING	RANGE	GRADUATION	UNIT RATE ₹
D51079000	K158/D	0.01mm / 0.0005 inch	0-200 mm / 0-8 inch	-	10,750.00
D51089000	K158/DP	0.001mm / 0.00005 inch	0-200 mm / 0-8 inch	-	15,690.00

DIAL THICKNESS GAUGES 130 Series (Throat Depth: 30 mm)

D60159000	K130/0	0.1 mm	10.0 mm	0-10	2,770.00
D61159000	K130/3	0.01 mm	10.0 mm	0-100	2,870.00
D63039000	K130/6	0.002 mm	2.0 mm	0-20	4,830.00
D63049000	K130/7	0.002 mm	5.0 mm	0-20	5,330.00
D62109000	K130/1	0.001 inch	0.5 inch	0-100	3,250.00
D64039000	K130/8	0.0001 inch	0.05 inch	0-100	5,300.00
D64049000	K130/9	0.0001 inch	0.2 inch	0-100	5,880.00

142 Series (Throat Depth: 100 mm)

D60229000	K142/0	0.1 mm	10.0 mm	0-10	3,090.00
D61149000	K142/3	0.01 mm	10.0 mm	0-100	3,220.00
D62129000	K142/1	0.001 inch	0.5 inch	0-100	3,520.00

138 Series (Push Down Type) (Throat Depth: 50 mm)

D60219000	K138/0	0.1 mm	25.0 mm	0-10	4,500.00
D61139000	K138/3	0.01 mm	25.0 mm	0-100	4,800.00
D62139000	K138/1	0.001 inch	1.0 inch	0-100	5,270.00

138 Series (Throat Depth: 50 mm)

D60249000	K138/0L	0.1 mm	25.0 mm	0-10	4,890.00
D61179000	K138/3L	0.01 mm	25.0 mm	0-100	5,180.00
D62119000	K138/1L	0.001 inch	1.0 inch	0-100	5,710.00

145 Series (Throat Depth: 200 mm)

D60139000	K145/0	0.1 mm	10.0 mm	0-10	3,890.00
D61119000	K145/3	0.01 mm	10.0 mm	0-100	4,100.00
D62089000	K145/1	0.001 inch	0.5 inch	0-100	4,340.00

150 Series (Throat Depth: 200 mm)

D60149000	K150/0	0.1 mm	25.0 mm	0-10	5,730.00
D61129000	K150/3	0.01 mm	25.0 mm	0-100	6,050.00
D62099000	K150/1	0.001 inch	1.0 inch	0-100	6,590.00

DIGITAL DIAL THICKNESS GAUGES 130 Series (Throat Depth: 30 mm)

PRODUCT CODE	TYPE	READING	RANGE	GRADUATION	UNIT RATE ₹
D60209000	K130/D	0.001 mm / 0.00005 inch	12.5 mm / 0.5 inch	-	30,920.00

142 Series (Throat Depth: 100 mm)

D60179000	K142/D	0.001 mm / 0.00005 inch	12.5 mm / 0.5 inch	-	31,180.00
-----------	--------	-------------------------	--------------------	---	-----------

138 Series (Throat Depth: 50 mm)

D60169000	K138/D	0.001 mm / 0.00005 inch	25 mm / 1.0 inch	-	32,380.00
-----------	--------	-------------------------	------------------	---	-----------

145 Series (Throat Depth: 200 mm)

D60189000	K145/D	0.001 mm / 0.00005 inch	12.5 mm / 0.5 inch	-	31,830.00
-----------	--------	-------------------------	--------------------	---	-----------

150 Series (Throat Depth: 200 mm)

D60199000	K150/D	0.001 mm / 0.00005 inch	25 mm / 1.0 inch	-	33,030.00
-----------	--------	-------------------------	------------------	---	-----------

ACCESSORIES FOR 'K' SERIES

PRODUCT CODE	DESCRIPTION	UNIT RATE RS.
D01009109	Tungsten Carbide Ball Anvil	160.00
D01009104	Saphire Ball Anvil	260.00
D01009103	Ruby Ball Anvil	470.00
D01009131	Flat Anvil 5 mm dia.	220.00
D60007020	Flat Anvil 10 mm dia.	290.00
D01009170	Flat Anvil 20 mm dia.	400.00
D46009030	Hemispherical Anvil	260.00
D01009141	Chisel Anvil	290.00
D01009151	Needle Anvil	270.00
D01009133	Stylus Anvil	290.00
D01009160	Conical Anvil	280.00
D01009135	Long Conical Point Anvil	330.00
D50009923	Rack Extension 25 mm	100.00
D50009924	Rack Extension 50 mm	120.00
D50009925	Rack Extension 100 mm	170.00
D01099910	Centre Lugback Cover	100.00
D01099913	Flat Back Cover	100.00
D01099912	Offset Lugback cover	100.00
D01099914	Sliding Back-Female	430.00
D01099915	Sliding Back-Male	390.00
D01099900	Sliding Back-Male with Spigot	520.00
D60009300	Lifting Lever- New	280.00
D01009940	Rubber Bellow	100.00

- "Certificate of Inspection" is provided with each gauge, traceable to National/International Length Standards.
- For NABL (National Accreditation Board for Testing & Calibration Laboratories) Certification, extra charges will be applicable, which can be made available on request. For NABL Scope of Accreditation, please refer page 27 & 28
- All Model 40 & Model 56 Plunger Type Dial Gauges are supplied fitted with Flat Back and a spare Central Lug Back in a plastic box.
- All Dial Gauges are supplied with Tungsten Carbide Ball Anvil.

INTERNAL GROOVE CALIPERS ACCESSORIES

PRODUCT CODE	DESCRIPTION	UNIT RATE ₹
D93069140	Contact Anvil 3 mm Lg	300.00
D93069141	Contact Anvil 4 mm Lg	300.00
D93069142	Contact Anvil 5 mm Lg	300.00
D93069143	Contact Anvil 6 mm Lg	300.00
D93069144	Contact Anvil 7 mm Lg	300.00
D93069145	Contact Anvil 8 mm Lg	300.00
D93069146	Contact Anvil 9 mm Lg	300.00
D93069147	Contact Anvil 10 mm Lg	300.00
D93069148	Contact Anvil 2 mm Lg	300.00
D93069201	Contact Anvil 2 mm IGC-SPT2-1	300.00
D93069202	Contact Anvil 3 mm IGC-SPT2-2	300.00
D93069203	Contact Anvil 4 mm IGC-SPT2-3	300.00
D93069204	Contact Anvil 5 mm IGC-SPT2-4	300.00
D93069205	Contact Anvil 6 mm IGC-SPT2-5	300.00
D93069206	Contact Anvil 7 mm IGC-SPT2-6	300.00
D93069207	Contact Anvil 8 mm IGC-SPT2-7	300.00
D93069208	Contact Anvil 9 mm IGC-SPT2-8	300.00
D93069209	Contact Anvil 10 mm IGC-SPT2-9	300.00
D93069211	Contact Anvil 2 mm IGC-SPT3-1	300.00
D93069212	Contact Anvil 3 mm IGC-SPT3-2	300.00
D93069213	Contact Anvil 4 mm IGC-SPT3-3	300.00
D93069214	Contact Anvil 5 mm IGC-SPT3-4	300.00
D93069215	Contact Anvil 6 mm IGC-SPT3-5	300.00
D93069216	Contact Anvil 7 mm IGC-SPT3-6	300.00
D93069217	Contact Anvil 8 mm IGC-SPT3-7	300.00
D93069218	Contact Anvil 9 mm IGC-SPT3-8	300.00
D93069219	Contact Anvil 10 mm IGC-SPT3-9	300.00

HEIGHT GAUGE ACCESSORIES

PRODUCT CODE	DESCRIPTION	UNIT RATE ₹
D63459000	Height Gauge Adaptor for Bevel Protractor	1210.00

SURFACE ROUGHNESS TESTER ACCESSORIES

PRODUCT CODE	DESCRIPTION	UNIT RATE ₹
E63081001	Adjustable Height Support Feet	1780.00
E63081002	Magnetic Stand Adapter	2490.00
E63081003	Height Gauge Adapter	7070.00
E63081004	Measurement Stand Small Size Aluminum Plate Lifting Height - 200mm	28290.00
E63081005	Measurement Stand Marble Plate Lifting Height - 350mm	63600.00
E63081006	Extension Rod (50mm)	10610.00
E63081007	Small Hole Sensor	106000.00
E63081008	Curved Surface Sensor	106000.00
E63081009	Extra Small Hole Sensor	106000.00
E63081010	Deep Groove Sensor	113080.00
E63081011	Nosepiece for Flat Surface	1780.00
E63081012	Nosepiece for Cylindrical Surface	1780.00
E63081013	Miniature Thermal Printer	17680.00

Spare parts list for Type : K01, K02, K03, K04, KY & KZ

REF NO.	PART NO.	PART DESCRIPTION	USED ON	UNIT RATE ₹
1	D01009060	TOLERANCE POINTER	K02,K01,K03,K04,KZ,KY	70.00
2	D01099050	CRYSTAL	K02,K01,K03,K04,KZ,KY	50.00
3	D01094020	OUTER DIAL SPACER	K02,K01,K03,K04,KZ,KY	50.00
4	D01094010	OUTER DIAL	K02, K04,	100.00
	D01354010	OUTER DIAL	K01,K03	100.00
	D01394010	OUTER DIAL	KZ,KY	100.00
5	D01006000	SMALL POINTER ASSLY.	K02,K01,K03,K04,KZ,KY	100.00
6	D01005000	LARGE POINTER ASSY	K02,K01,K03,K04,KZ,KY	100.00
7	D01093020	INNER DIAL	GIVE TYPE NO	120.00
8	D01003010	O RING	K02,K01,K03,K04,KZ,KY	30.00
9	D01099040	K02 BEZEL AL BLACK	K02,K01,K03,K04,KZ,KY	120.00
10	D01091082	BOTTOM PLATE SCREW (M2x6MM Lg)	K02,K01,K03,K04,KZ,KY	30.00
11	D01009010	B/Z RETAINING WASHER F/R	K02,K01,K03,K04,KZ,KY	30.00
12	D01009020	B/Z RETAINING WASHER H/R	K02,K01,K03,K04,KZ,KY	30.00
13	D01131100	BOTTOM PLATE SUB ASSY	K02,K01,K03,K04,KZ,KY	410.00
14	D01001010	BACKLASH HAIR SPRING PIN	K02,K01,K03,K04,KZ,KY	40.00
15	D01091020	CENTER PINION	K02,K01,K03,K04,KZ,KY	170.00
16	D01001400	RACK WHEEL & BOSS ASSY	K02,K01,K03,K04,KZ,KY	180.00
17	D01091200	B/L SPINDLE & WHEEL ASSY	K02,K01,K03,K04,KZ,KY	130.00
18	D01091500	RACK PINION & PIN ASSY	K02,K01,K03,K04,KZ	130.00
19	D01091300	BACKLASH HAIR SPRING	K02,K01,K03,K04,KZ,KY	110.00
20	D01091900	TOP PLATE & HOUSING ASSLY	K02,K01,K03,K04,KZ,KY	90.00
21	D01001080	PH CHEESE HD SCREW(M2x4MM Lg)	K02,K01,K03,K04,KZ,KY	30.00
22	D01009613	TOP SCREW FOR FLOATING TOP CAP	K02,K01,K03,K04,KZ,KY	60.00
23	D01009603	FLOATING TOP CAP	K02,K01,K03,K04,KZ,KY	60.00
24	D01002062	TOP KNOB AND BEZEL CLAMP BLACK	K02,K01,K03,K04,KZ,KY	50.00
25	D01099071	BEZEL CLAMP	K02,K01,K03,K04,KZ,KY	40.00
26	D01002130	TOP BRG PLAIN	K02,K01,K03,K04,KZ,KY	50.00
27	D01092101	CASE & BEARING ASSLY	K02,K01,K03,K04,KZ,KY	560.00
28	D01092040	TENSION SPRING	K02,K01,K03,K04,KZ,	50.00
29	D01099910	CENTER LUGBACK COVER	K02,K01,K03,K04,KZ,KY	100.00
30	D01099913	FLAT BACK	K02,K01,K03,K04,KZ,KY	100.00
31	D01001080	PH CHEESE HD SCREW(M2x4MM Lg)	K02,K01,K03,K04,KZ,KY	30.00
32	D01092170	BOTTOM BEARING LINER	K02,K01,K03,K04,KZ,KY	40.00
33	D01002010	PLUNGER	K02,K01	260.00
	D01022010	PLUNGER	K03,K04,KZ	260.00
	D25002010	PLUNGER	KY	520.00
34	D01002050	PLUNGER STOP SCREW	K02,K01,K03,K04,KZ,KY	30.00
35	D01092020	PLUNGER GUIDE PIN	K02,K01,K03,K04,KZ,KY	40.00
36	D01009109	T.C. BALL ANVIL	K02,K01,K03,K04,KZ,KY	150.00

DIAL GAUGE SPARES



Spare parts list for Type : K06, K06A, K08, K49, K50, K57, K58

REF NO.	PART NO.	PART DESCRIPTION	USED ON	UNIT RATE ₹
1	D01009060	TOLERANCE POINTER	K06,K08,K50,K49,K57,K58	70.00
2	D01099050	CRYSTAL	K06,K08,K50,K49,K57,K58	50.00
3	D01094020	OUTER DIAL SPACER	K06,K08,K50,K49,K57,K58	50.00
4	D01094010	OUTER DIAL	K08,K50	100.00
	D06114010	OUTER DIAL	k06	100.00
	D16054010	OUTER DIAL	k57	100.00
	D16064010	OUTER DIAL	k49,k58	100.00
5	D01006000	SMALL POINTER ASSLY.	K06,K08,K50,K49,K57,K58	100.00
6	D01005000	LARGE POINTER ASSY	K06,K08,K50,K49,K57,K58	100.00
7	D01383020	INNER DIAL	GIVETYPENO	120.00
8	D01003010	O RING	K06,K08,K50,K49,K57,K58	30.00
9	D01099040	K02 BEZEL AL BLACK	K06,K08,K50,K49,K57,K58	120.00
10	D01091082	BOTTOM PLATE SCREW (M2x6MM Lg)	K06,K08,K50,K49,K57,K58	30.00
11	D01009010	B/Z RETAINING WASHER F/R	K06,K08,K50,K49,K57,K58	30.00
12	D01009020	B/Z RETAINING WASHER H/R	K06,K08,K50,K49,K57,K58	30.00
13	D01091100	BOTTOM PLATE SUB ASSY	K06,K08,K50,K49,K57,K58	410.00
14	D01001010	BACKLASH HAIR SPRING PIN	K06,K08,K50,K49,K57,K58	40.00
15	D01091020	CENTER PINION	K08,K57,K58	180.00
	D06111020	CENTER PINION	K06	180.00
	D11081020	CENTER PINION	K50,K49,	180.00
	D06151020	CENTER PINION	K06A	180.00
16	D01381800	B/L INT PINION & WHEEL ASSY	K08,K57,K58	250.00
	D11081800	B/L INT PINION & WHEEL ASSY	K50,K49,	250.00
17	D01381600	RACK PINION & WHEEL ASSEMBLY	K08	300.00
	D06111600	RACK PINION & WHEEL ASSEMBLY	K06	300.00
	D11081600	RACK PINION & WHEEL ASSEMBLY	K50,K49,	300.00
	D16051600	RACK PINION & WHEEL ASSEMBLY	K57,K58	300.00
	D01381200	B/L SPINDLE & WHEEL ASSY	K08,K57,K58	130.00
18	D06111200	B/L SPINDLE & WHEEL ASSY	K06	130.00
	D11081200	B/L SPINDLE & WHEEL ASSY	K50,K49	130.00
	D06151200	B/L SPINDLE & WHEEL ASSY	K06A	130.00
19	D01091300	BACKLASH HAIR SPRING	K06,K08,K50,K49,K57,K58	110.00
20	D01091900	TOP PLATE & HOUSING ASSLY	K06,K08,K50,K49,K57,K58	90.00
21	D01001080	PH CHEESE HD SCREW(M2x4MM Lg)	K06,K08,K50,K49,K57,K58	30.00
22	D01009613	TOP SCREW FOR FLOATING TOP CAP	K06,K08,K50,K49,K57,K58	60.00
23	D01009603	FLOATING TOP CAP	K06,K08,K50,K49,K57,K58	60.00
24	D01002062	TOP KNOB AND BEZEL CLAMP BLACK	K06,K08,K50,K49,K57,K58	50.00
25	D01099071	BEZEL CLAMP	K06,K08,K50,K49,K57,K58	40.00
26	D01002130	TOP BRG PLAIN	K06,K08,K50,K49,K57,K58	50.00
27	D01382101	CASE & BEARING ASSLY	K06,K08,K50,K49,K57,K58	560.00
28	D01382030	PLUNGER GUIDE	K06,K08,K50,K49,K57,K58	260.00
29	D01382090	K08 RACK/SPRING SCREW	K06,K08,K50,K49,K57,K58	40.00
30	D01002041	TENSION SPRING	K06,K08,K50,K49,K57,K58	50.00
31	D01099910	CENTER LUGBACK COVER	K06,K08,K50,K49,K57,K58	100.00
32	D01001080	PH CHEESE HD SCREW(M2x4MM Lg)	K06,K08,K50,K49,K57,K58	30.00
33	D01099913	FLAT BACK	K06,K08,K50,K49,K57,K58	100.00
35	D01132010	PLUNGER	K08	380.00
	D06012010	PLUNGER	K06	260.00
	D11032010	PLUNGER	K50,K49,K57,K58	450.00
36	D01002050	PLUNGER STOP SCREW	K06,K08,K50,K49,K57,K58	30.00
37	D01382020	PLUNGER GUIDE PIN 1"	K06,K08,K50,K49,K57,K58	40.00
38	D01009109	T.C. BALL ANVIL	K06,K08,K50,K49,K57,K58	150.00

Spare parts list for Type : K05, K45, K46, K51, K52, K53, K54 & K55

REF NO.	PART NO.	PART DESCRIPTION	USED ON	UNIT RATE ₹
1	D01009060	TOLERANCE POINTER	K05,K45,K46,K51,K52,K55,K56,K53,K54	70.00
2	D01099050	CRYSTAL	K05,K45,K46,K51,K52,K55,K56,K53,K54	50.00
3	D01094020	OUTER DIAL SPACER	K05,K45,K46,K51,K52,K55,K56,K53,K54	50.00
4	D06114010	OUTER DIAL	K05,	100.00
	D01354010	OUTER DIAL	K45,K51,	100.00
	D01094010	OUTER DIAL	K46,K52,	100.00
	D16054010	OUTER DIAL	K55,K53,	100.00
	D16064010	OUTER DIAL	K56,K54	100.00
5	D01006000	SMALL POINTER ASSLY.	K05,K45,K46,K51,K52,K55,K56,K53,K54	100.00
6	D01005000	LARGE POINTER ASSY	K05,K45,K46,K51,K52,K55,K56,K53,K54	100.00
7	D01093020	INNER DIAL	GIVE TYPE NO.	120.00
8	D01003010	O RING	K05,K45,K46,K51,1`K55,K56,K53,K54	30.00
9	D01099040	K02 BEZEL AL BLACK	K05,K45,K46,K51,K52,K55,K56,K53,K54	120.00
10	D01091082	BOTTOM PLATE SCREW (M2x6MM Lg)	K05,K45,K46,K51,K52,K55,K56,K53,K54	30.00
11	D01009010	B/Z RETAINING WASHER F/R	K05,K45,K46,K51,K52,K55,K56,K53,K54	30.00
12	D01009020	B/Z RETAINING WASHER H/R	K05,K45,K46,K51,K52,K55,K56,K53,K54	30.00
13	D01131100	BOTTOM PLATE SUB ASSY	K05,K45,K46,K51,K52,K55,K56,K53,K54	420.00
14	D01001010	BACKLASH HAIR SPRING PIN	K05,K45,K46,K51,K52,K55,K56,K53,K54	40.00
15	D01091020	CENTER PINION	K55,K56,K53,K54	180.00
	D06111020	CENTER PINION	K05,	180.00
	D11081020	CENTER PINION	K45,K46,K51,K52,	180.00
16	D06111600	RACK PINION & WHEEL ASSEMBLY	K05,	380.00
	D11081600	RACK PINION & WHEEL ASSEMBLY	K45,K46,K51,K52,	380.00
	D16051600	RACK PINION & WHEEL ASSEMBLY	K55,K56,K53,K54	380.00
17	D01091200	B/L SPINDLE & WHEEL ASSY	K55,K56,K53,K54	130.00
	D06111200	B/L SPINDLE & WHEEL ASSY	K05,	130.00
	D11091200	B/L SPINDLE & WHEEL ASSY	K45,K46,K51,K52,	130.00
18	D01091300	BACKLASH HAIR SPRING	K05,K45,K46,K51,K52,K55,K56,K53,K54	110.00
19	D01001080	PH CHEESE HD SCREW(M2x4MM Lg)	K05,K45,K46,K51,K52,K55,K56,K53,K54	30.00
20	D01091900	TOP PLATE & HOUSING ASSLY	K05,K45,K46,K51,K52,K55,K56,K53,K54	90.00
21	D01009613	TOP SCREW FOR FLOATING TOP CAP	K05,K45,K46,K51,K52,K55,K56,K53,K54	60.00
22	D01009603	FLOATING TOP CAP	K05,K45,K46,K51,K52,K55,K56,K53,K54	60.00
23	D01002062	TOP KNOB AND BEZEL CLAMP BLACK	K05,K45,K46,K51,K52,K55,K56,K53,K54	50.00
24	D01099071	BEZEL CLAMP	K05,K45,K46,K51,K52,K55,K56,K53,K54	40.00
25	D01002130	TOP BRG PLAIN	K05,K45,K46,K51,K52,K55,K56,K53,K54	50.00
26	D01092101	CASE & BEARING ASSLY	K45,K46,K51,K52,K55,K56,K53,K54	560.00
	D06112101	CASE & BEARING ASSLY	K05,	560.00
27	D01092040	TENSION SPRING	K05,K45,K46,K51,K52,K55,K56,K53,K54	50.00
28	D01099910	CENTER LUGBACK COVER	K05,K45,K46,K51,K52,K55,K56,K53,K54	100.00
29	D01001080	PH CHEESE HD SCREW(M2x4MM Lg)	K05,K45,K46,K51,K52,K55,K56,K53,K54	30.00
30	D01099913	FLAT BACK	K05,K45,K46,K51,K52,K55,K56,K53,K54	100.00
31	D01092170	BOTTOM BEARING LINER	K05,K45,K46,K51,K52,K55,K56,K53,K54	40.00
32	D06002010	PLUNGER	K05,	260.00
	D11012010	PLUNGER	K45,K46,K51,K52,K55,K56,K53,K54	260.00
33	D01002050	PLUNGER STOP SCREW	K05,K45,K46,K51,K52,K55,K56,K53,K54	30.00
34	D01092020	PLUNGER GUIDE PIN	K05,K45,K46,K51,K52,K55,K56,K53,K54	40.00
35	D01009109	T.C. BALL ANVIL	K05,K45,K46,K51,K52,K55,K56,K53,K54	150.00

DIAL GAUGE SPARES



Spare parts list for Type : K09, K10, K11, K12, K13, K14, K61, K62, K63, K64

REF NO.	PART NO.	PART DESCRIPTION	USED ON	UNIT RATE ₹
1	D01009060	TOLERANCE POINTER	K12, K09, K10, K11, K13, K14, K62, K61, K63, K64	70.00
2	D01099050	CRYSTAL	K12, K09, K10, K11, K13, K14, K62, K61, K63, K64	50.00
3	D01094020	OUTER DIAL SPACER	K12, K09, K10, K11, K13, K14, K62, K61, K63, K64	50.00
4	D23114010	OUTER DIAL	K12, K09, K10, K14	100.00
	D23124010	OUTER DIAL	K11, K13	100.00
	D01094010	OUTER DIAL	K62, K64	100.00
	D01354010	OUTER DIAL	K61, K63	100.00
5	D01006000	SMALL POINTER ASSLY.	K12, K09, K10, K11, K13, K14, K62, K61, K63, K64	100.00
6	D01005000	LARGE POINTER ASSY	K12, K09, K10, K11, K13, K14, K62, K61, K63, K64	100.00
7	D23113020	INNER DIAL	GIVE TYPE NO	120.00
8	D01003010	O RING	K12, K09, K10, K11, K13, K14, K62, K61, K63, K64	30.00
9	D01099040	K02 BEZEL AL BLACK	K12, K09, K10, K11, K13, K14, K62, K61, K63, K64	120.00
10	D01091082	BOTTOM PLATE SCREW (M2x6MM Lg)	K12, K09, K10, K11, K13, K14, K62, K61, K63, K64	30.00
11	D01009010	B/Z RETAINING WASHER F/R	K12, K09, K10, K11, K13, K14, K62, K61, K63, K64	30.00
12	D01009020	B/Z RETAINING WASHER H/R	K12, K09, K10, K11, K13, K14, K62, K61, K63, K64	30.00
13	D23111101	BOTTOM PLATE SUB ASSY	K12, K09, K10, K11, K13, K14, K62, K61, K63, K64	480.00
14	D01001010	BACKLASH HAIR SPRING PIN	K12, K09, K10, K11, K13, K14, K62, K61, K63, K64	40.00
15	D01091020	CENTER PINION	K12, K09, K10, K11, K13, K14, K62, K61, K63, K64	180.00
16	D01381800	B/L INT PINION & WHEEL ASSY	K12, K09, K10, K11, K13, K14, K62, K61, K63, K64	240.00
17	D23111600	RACK PINION & WHEEL ASSEMBLY	K12, K09, K10, K11, K13, K14	350.00
	D25091600	RACK PINION & WHEEL ASSEMBLY	K62, K61	350.00
	D25111600	RACK PINION & WHEEL ASSEMBLY	K63, K64	350.00
18	D23111200	B/L SPINDLE & WHEEL ASSY	K12, K09, K10, K11, K62, K61	130.00
	D23151200	B/L SPINDLE & WHEEL ASSY	K13, K14, K63, K64	130.00
19	D01091300	BACKLASH HAIR SPRING	K12, K09, K10, K11, K13, K14, K62, K61, K63, K64	110.00
20	D23111700	INTER PINION & WHEEL ASSLY.	K12, K09, K10, K11, K13, K14, K62, K61, K63, K64	240.00
21	D23111900	TOP PLATE ASSLY BETA K SERIES	K12, K09, K10, K11, K13, K14, K62, K61, K63, K64	100.00
22	D30001720	JEWEL	K12, K09, K10, K11, K13, K14, K62, K61, K63, K64	70.00
23	D01001080	PH CHEESE HD SCREW(M2x4MM Lg)	K12, K09, K10, K11, K13, K14, K62, K61, K63, K64	30.00
24	D01009613	TOP SCREW FOR FLOATING TOP CAP	K12, K09, K10, K11, K13, K14, K62, K61, K63, K64	60.00
25	D01009603	FLOATING TOP CAP	K12, K09, K10, K11, K13, K14, K62, K61, K63, K64	60.00
26	D01002062	TOP KNOB AND BEZEL CLAMP BLACK	K12, K09, K10, K11, K13, K14, K62, K61, K63, K64	50.00
27	D01099071	BEZEL CLAMP	K12, K09, K10, K11, K13, K14, K62, K61, K63, K64	40.00
28	D01002130	TOP BRG PLAIN	K12, K09, K10, K11, K13, K14, K62, K61, K63, K64	50.00
29	D23112101	CASE & BEARING ASSLY	K12, K09, K10, K11, K13, K14, K62, K61, K63, K64	210.00
30	D23112040	TENSION SPRING	K12, K09, K10, K11, K13, K14, K62, K61, K63, K64	50.00
31	D01099910	CENTER LUGBACK COVER	K12, K09, K10, K11, K13, K14, K62, K61, K63, K64	100.00
32	D01001080	PH CHEESE HD SCREW(M2x4MM Lg)	K12, K09, K10, K11, K13, K14, K62, K61, K63, K64	30.00
33	D01099913	FLAT BACK	K12, K09, K10, K11, K13, K14, K62, K61, K63, K64	100.00
34	D01092170	BOTTOM BEARING LINER	K12, K09, K10, K11, K13, K14, K62, K61, K63, K64	40.00
35	D23012010	PLUNGER	K09, K10	520.00
	D23002010	PLUNGER	K12, K11	520.00
	D23082010	PLUNGER	K13, K14	520.00
	D25002010	PLUNGER	K62, K61	520.00
	D11012010	PLUNGER	K63, K64	260.00
36	D01002050	PLUNGER STOP SCREW	K12, K09, K10, K11, K13, K14, K62, K61, K63, K64	30.00
37	D01092020	PLUNGER GUIDE PIN	K12, K09, K10, K11, K13, K14, K62, K61, K63, K64	40.00
38	D01009109	T.C. BALL ANVIL	K12, K09, K10, K11, K13, K14, K62, K61, K63, K64	150.00

Spare parts list for Type : K17S

REF NO.	PART NO.	PART DESCRIPTION	UNIT RATE ₹
1	D01009060	TOLERANCE POINTER	70.00
2	D01099050	CRYSTAL	50.00
3	D01094020	OUTER DIAL SPACER	50.00
4	D28074010	OUTER DIAL	100.00
5	D01005000	LARGE POINTER ASSY	100.00
6	D01006000	SMALL POINTER ASSLY.	100.00
7	D28083020	INNER DIAL	120.00
8	D01003010	O RING	30.00
9	D01099040	K02 BEZEL AL BLACK	120.00
10	D01091082	BOTTOM PLATE SCREW (M2x6MM Lg)	30.00
11	D01009010	B/Z RETAINING WASHER F/R	30.00
12	D01009020	B/Z RETAINING WASHER H/R	30.00
13	D28081100	BOTTOM PLATE SUB ASSY	480.00
15	D01001010	BACKLASH HAIR SPRING PIN	40.00
14	D28081020	CENTER PINION	180.00
16	D28081600	RACK PINION & WHEEL ASSEMBLY	290.00
17	D28081200	B/L SPINDLE & WHEEL ASSY	130.00
18	D28081300	BACKLASH HAIR SPRING	100.00
19	D28081900	TOP PLATE & JEWEL ASSLY	180.00
20	D01001080	PH CHEESE HD SCREW(M2x4MM Lg)	30.00
21	D28081180	ADJUSTABLE STOPPER	20.00
22	D40002060	SCREW FOR ADJUSTABLE STOPPER	20.00
23	D30031720	OLIVE JEWEL	70.00
24	D28081060	CAM ADJUSTMT SCREW	60.00
25	D28081800	CAM & PIN ASSLY	180.00
26	D28081050	CAM SCREW	20.00
27	D28081401	SEGMENT & SPINDLE ASSLY	110.00
28	D30001700	JEWEL HOUSING ASSY	110.00
29	D01009570	TOP CAP	40.00
30	D01002061	TOP SCREW	40.00
31	D01002062	TOP KNOB AND BEZEL CLAMP BLACK	50.00
32	D01099071	BEZEL CLAMP	40.00
33	D28082100	CASE & BEARING ASSLY	560.00
34	D28082040	TENSION SPRING	50.00
35	D01099913	FLAT BACK	100.00
36	D01099910	CENTER LUGBACK COVER	100.00
37	D01001080	PH CHEESE HD SCREW(M2x4MM Lg)	30.00
38	D01002050	PLUNGER STOP SCREW	30.00
39	D28082071	SEGMENT PIN	70.00
40	D01092020	PLUNGER GUIDE PIN	40.00
41	D28082010	PLUNGER	260.00
42	D01009109	T.C. BALL ANVIL	150.00
43	D30001712	LOCKING RING	40.00
44	D01002061	TOP SCREW	40.00

DIAL GAUGE SPARES



Spare parts list for Type : K35, K36, K39, K40, K40Z, K41, K42, K43

REF NO.	PART NO.	PART DESCRIPTION	USED ON	UNIT RATE ₹
1	D01459060	TOLERANCE POINTER	K40,K39,K41,K42,K35,K36,K43,K40Z	30.00
2	D01459050	CRYSTAL	K40,K39,K41,K42,K35,K36,K43,K40Z	40.00
3	D01454020	DIAL SPACER	K40,K39,K41,K42,K35,K36,K43,K40Z	30.00
4	D01454010	OUTER DIAL	K40,K42	100.00
4	D06254010	OUTER DIAL	K35	100.00
4	D01464010	OUTER DIAL	K39,K41,	100.00
4	D05514010	OUTER DIAL	K36,K43	100.00
4	D01344010	OUTER DIAL	K40Z	100.00
5	D01456000	SMALL POINTER ASSLY.	K40,K39,K41,K42,K35,K36,K43,K40Z	40.00
6	D04755000	LARGE POINTER ASSY	K40,K39,K41,K42,K35,K36,K43,K40Z	40.00
7	D01453020	INNER DIAL		120.00
8	D01003010	O RING	K40,K39,K41,K42,K35,K36,K43,K40Z	30.00
9	D01459040	BEZEL	K40,K39,K41,K42,K35,K36,K43,K40Z	120.00
10	D01001080	PH CHEESE HD SCREW(M2x4MM Lg)	K40,K39,K41,K42,K35,K36,K43,K40Z	30.00
11	D01451100	BOTTOM PLATE SUB ASSY	K40,K39,K41,K42,K35,K36,K43,K40Z	420.00
12	D01001010	BACKLASH HAIR SPRING PIN	K40,K39,K41,K42,K35,K36,K43,K40Z	40.00
13	D01451200	B/L SPINDLE & WHEEL ASSY	K40,K39,K36K43,K40Z	130.00
13	D11121200	B/L SPINDLE & WHEEL ASSY	K41,K42	130.00
14	D01451600	RACK PINION & WHEEL ASSEMBLY	K40,K39,	300.00
14	D11121600	RACK PINION & WHEEL ASSEMBLY	K41,K42	300.00
14	D06251600	RACK PINION & WHEEL ASSEMBLY	K35	300.00
14	D01311600	RACK PINION & WHEEL ASSEMBLY	K36	300.00
14	D05511600	RACK PINION & WHEEL ASSEMBLY	K43	300.00
14	D01341500	RACK PINION & PIN ASSLY	K40Z	120.00
14	D01341400	RACK WHEEL & BOSS ASSY	K40Z	180.00
15	D01451020	CENTER PINION	K40,K39,K36,K43,K40Z	170.00
15	D11121020	CENTER PINION	K41,K42	170.00
15	D06251020	CENTER PINION	K35	170.00
16	D01451300	BACKLASH SPRING	K40,K39,K41,K42,K35,K36,K43,K40Z	40.00
17	D01451900	TOP PLATE & HOUSING ASSLY	K40,K39,K41,K42,K35,K36,K43,K40Z	80.00
18	D01091080	CHEESE HEAD SCREW M2 X 6MM	K40,K39,K41,K42,K35,K36,K43,K40Z	30.00
19	D01459613	SCREW FOR FLOATING TOP CAP	K40,K39,K41,K42,K35,K36,K43,K40Z	30.00
20	D01459603	FLOATING TOP CAP	K40,K39,K41,K42,K35,K36,K43,K40Z	30.00
21	D01002062	TOP KNOB AND BEZEL CLAMP BLACK	K40,K39,K41,K42,K35,K36,K43,K40Z	50.00
22	D01099071	BEZEL CLAMP	K40,K39,K41,K42,K35,K36,K43,K40Z	40.00
23	D01452040	TENSION SPRING	K40,K39,K41,K42,K35,K36,K43,K40Z	50.00
24	D01459910	CENTER LUGBACK COVER	K40,K39,K41,K42,K35,K36,K43,K40Z	40.00
25	D01459911	FLAT BACK	K40,K39,K41,K42,K35,K36,K43,K40Z	30.00
26	D01001080	PH CHEESE HD SCREW(M2x4MM Lg)	K40,K39,K41,K42,K35,K36,K43,K40Z	30.00
27	D01452100	CASE & BEARING ASSLY	K40,K39,K41,K42,K35, K43,K40Z	850.00
27	D01312100	CASE & BEARING ASSLY	K36	850.00
28	D01452170	BOTTOM BEARING LINER	K40,K39,K41,K42,K35,K36,K43,K40Z	20.00
29	D01452050	STOP SCREW	K40 K40,K39,K41,K42,K35,K36,K43,K40Z	30.00
30	D01452020	RACK GUIDE PIN	K40,K39,K41,K42,K35,K36,K43,K40Z	40.00
31	D01452010	PLUNGER	K40,K39,K36,K40Z	260.00
31	D11122010	PLUNGER	K41,K42,K43	260.00
31	D06252010	PLUNGER	K35	260.00
32	D01009109	T.C. BALL ANVIL	K40,K39,K41,K42,K35,K36,K43,K40Z	150.00
33	D01311700	INTER PINION & WHEEL ASSLY.	K36	250.00

Spare parts list for Type : J72 & J76

REF NO.	PART NO.	PART DESCRIPTION	USED ON	UNIT RATE ₹
1	D01149060	TOLERANCE POINTER	J72,J76,	330.00
2	D01149050	CRYSTAL	J72,J76,	160.00
3	D01144020	SPACER	J72,J76,	240.00
4	D01006000	SMALL POINTER ASSLY.	J72,J76,	100.00
5	D01145000	LARGE POINTER ASSY	J72,J76,	110.00
6	D01144010	OUTER DIAL	GIVE TYPE NO	190.00
7	D01143021	INNER DIAL	GIVE TYPE NO	230.00
8	D01003010	O RING	J72,J76,	30.00
9	D01149040	BEZEL	J72,J76,	510.00
10	D01091082	BOTTOM PLATE SCREW (M2x6MM Lg)	J72,J76,	30.00
11	D01009010	B/Z RETAINING WASHER F/R	J72,J76,	30.00
12	D01009020	B/Z RETAINING WASHER H/R	J72,J76,	30.00
13	D01002061	TOP SCREW	J72,J76,	40.00
14	D01141100	BOTTOM PLATE SUB ASSY	J72,	420.00
	D11041100	BOTTOM PLATE SUB ASSY	J76,	420.00
15	D01001010	BACKLASH HAIR SPRING PIN	J72,J76,	40.00
16	D01001200	B/L SPINDLE & WHEEL ASSY	J72,	130.00
	D11041200	B/L SPINDLE & WHEEL ASSY	J76,	130.00
17	D01001020	CENTER PINION	J72,	180.00
	D11001020	CENTER PINION	J76,	180.00
18	D01041600	RACK PINION & WHEEL ASSEMBLY	J72,	300.00
	D11001600	RACK PINION & WHEEL ASSEMBLY	J76,	300.00
19	D01141800	B/L INT PINION & WHEEL ASSY	J72,	130.00
	D11041800	B/L INT PINION & WHEEL ASSY	J76,	130.00
20	D01141300	BACKLASH HAIR SPRING	J72,J76,	110.00
21	D01141030	TOP PLATE	J72,	70.00
	D11041030	TOP PLATE	J76,	70.00
22	D01002061	TOP SCREW	J72,J76,	40.00
23	D01141040	CENTER PLATE	J72,	120.00
	D11041040	CENTER PLATE	J76,	120.00
24	D01001080	PH CHEESE HD SCREW(M2x4MM Lg)	J72,J76,	30.00
25	D01142070	CSK HEAD SCREW	J72,J76,	30.00
26	D01142061	TOP KNOB	J72,J76,	40.00
27	A95010007	O RING	J72,J76,	30.00
28	D73009043	WASHER	J72,J76,	30.00
29	D01002062	TOP KNOB AND BEZEL CLAMP BLACK	J72,J76,	50.00
30	D01002170	BOTTOM BEARING LINER	J72,J76,	40.00
31	D01009070	BEZEL CLAMP	J72,J76,	40.00
32	D01142100	CASE & BEARING ASSLY	J72,J76,	2100.00
33	D01142040	TENSION SPRING	J72,J76,	50.00
34	D01142200	PLUNGER GUIDE ASSEMBLY	J72,J76,	450.00
35	D01149910	CENTRE BACKLUG COVER	J72,J76,	190.00
36	D01042070	RETAINING SCREW TENSION SPRING	J72,J76,	30.00
37	D01001080	PH CHEESE HD SCREW(M2x4MM Lg)	J72,J76,	30.00
38	D01149911	FLAT BACK	J72,J76,	190.00
39	D01142010	PLUNGER	J72,	600.00
	D11042010	PLUNGER	J76,	600.00
	D11572010	PLUNGER	jb76	600.00
40	D01142020	PLUNGER GUIDE PIN	J72,J76,	40.00
41	D01009109	T.C. BALL ANVIL	J72,J76,	150.00

DIAL GAUGE SPARES

Spare parts list for Type : K101

REF NO.	PART NO.	PART DESCRIPTION	UNIT RATE ₹
1	D01069060	TOLERANCE POINTER	110.00
2	D01069050	CRYSTAL	50.00
3	D01064020	SPACER M100	120.00
4	D01064010	OUTER DIAL	100.00
5	D01006000	SMALL POINTER ASSLY.	100.00
6	D01065000	LARGE POINTER ASSY	40.00
7	D01403020	INNER DIAL	120.00
8	D01003010	O RING	30.00
9	D01409040	BEZEL	1040.00
10	D01091082	BOTTOM PLATE SCREW (M2x6MM Lg)	30.00
11	D01009010	B/Z RETAINING WASHER F/R	30.00
12	D01009020	B/Z RETAINING WASHER H/R	30.00
13	D01131100	BOTTOM PLATE SUB ASSY	420.00
14	D01001010	BACKLASH HAIR SPRING PIN	40.00
15	D01091020	CENTER PINION	170.00
16	D01001400	RACK WHEEL & BOSS ASSY	180.00
17	D01091200	B/L SPINDLE & WHEEL ASSY	130.00
18	D01091500	RACK PINION & PIN ASSY	130.00
19	D01091300	BACKLASH HAIR SPRING	110.00
20	D01091900	TOP PLATE & HOUSING ASSLY	90.00
21	D01001080	PH CHEESE HD SCREW(M2x4MM Lg)	30.00
22	D01009613	TOP SCREW FOR FLOATING TOP CAP	60.00
23	D01009603	FLOATING TOP CAP	60.00
24	D01062060	TOP KNOB AND BEZEL CLAMP BLACK	20.00
25	D01099071	BEZEL CLAMP	40.00
26	D01002130	TOP BRG PLAIN	50.00
27	D01092101	CASE & BEARING ASSLY	560.00
28	D01092040	TENSION SPRING	50.00
29	D01099910	CENTER LUGBACK COVER	100.00
30	D01099913	FLAT BACK	100.00
31	D01001080	PH CHEESE HD SCREW(M2x4MM Lg)	30.00
32	D01092170	BOTTOM BEARING LINER	40.00
33	D01062140	SLEEVE	90.00
34	D01002010	PLUNGER	260.00
35	D01002050	PLUNGER STOP SCREW	30.00
36	D01092020	PLUNGER GUIDE PIN	40.00
37	D01009921	EXTENSION 13MM	70.00
38	D01009109	T.C. BALL ANVIL	150.00

Spare parts list for Type : K100

REF NO.	PART NO.	PART DESCRIPTION	UNIT RATE ₹
1	D05509010	CRYSTAL	290.00
2	D01009109	MEASURING POINTER	120.00
3	D05509910	BACK PLATE	290.00
4	D05509020	TOLERANCE POINTER	120.00



DIAL GAUGE SPARES

Spare parts list for Type : A51, A52, F01, F02, F51, F52

REF NO.	PART NO.	PART DESCRIPTION	USED ON	UNIT RATE ₹
1	D40001020	CRYSTAL M40	F02,F01,F51,F52,A51,A52,	40.00
2	D40001010	BEZEL FOR M40	F02,F01,F51,F52,A51,A52,	90.00
3	D40009020	BEZEL RETAINING C CLIP M40	F02,F01,F51,F52,A51,A52,	30.00
4	D40003000	POINTER ASSY	F02,F01,F51,F52,A51,A52,	40.00
5	D40009011	DIAL F02, YELLOW	F02,	110.00
6	D40009040	DIAL SPRING M40	F02,F01,F51,F52,A51,A52,	30.00
7	D40002060	CHEESE HD SCREW M2X2.5 LG.	F02,F01,F51,F52,A51,A52,	20.00
8	D40002050	TOP PLATE	F02,F01,F51,F52,A51,A52,	50.00
9	D40002430E	BACKLASH SPRING	F02,F01,F51,F52,A51,A52,	220.00
10	D40002400	B/L SPINDLE & WHEEL ASSY	F02,F01,	80.00
	D42002400	B/L SPINDLE & WHEEL ASSY	F51,F52,A51,A52,	80.00
11	D40002200	WORM & WHEEL ASSY	F02,F01,	180.00
	D42002200	WORM & WHEEL ASSY	F51,F52,A51,A52,	180.00
12	D40002040	CENTER PINION	F02,F01,	90.00
	D42002040	CENTER PINION	F51,F52,A51,A52,	110.00
13	D40002080	CHEESE HD SCREW M2X8.1 LG.	F02,F01,F51,F52,A51,A52,	20.00
14	D40002011	RACK GUIDE	F02,F01,	180.00
	D42002011	RACK GUIDE	F51,F52,A51,A52,	180.00
15	D40002030	RETURN SPRING	F02,F01,F51,F52,A51,A52,	20.00
16	D40002020	PLUNGER STOP SCREW	F02,F01,F51,F52,A51,A52,	20.00
17	D40002100	CASE & BEARING SUB ASSY	F02,F01,F51,F52,	880.00
	D42502100	CASE & BEARING SUB ASSY 3/8"	A51,A52,	880.00
18	D40002310	PLUNGER M2.5	F02,F01,F51,F52,	60.00
	D42502310	PLUNGER 4-48	A51,A52,	60.00
19	D40002321	PLUNGER PIN NEW	F02,F01,F51,F52,A51,A52,	40.00
20	D01009109	T.C. BALL ANVIL M 2.5	F02,F01,F51,F52,A51,A52,	150.00
21	D40009030	STEM	F02,F01,F51,F52,A51,A52,	40.00

Spare parts list for Type : 301, 301A, 301L, 301AL, 302, 302A, 302L, 302AL, 303, 303A, 303L, 303AL, 304, 304A, 304L, 304AL, 305, 305A, 305L, 305AL, 306, 306A, 306L, 306AL, 307, 307A, 307L, 307AL, 308, 308A, 308L, 308AL

REF NO.	PART NO.	PART DESCRIPTION	USED ON	UNIT RATE ₹
	D30004020	CRYSTAL	302, 302A, 301, 301A, 304, 304A, 303, 303A, 302L, 302AL 301L, 301AL,	50.00
	D40001020	CRYSTAL	306, 306A, 305, 305A 308, 308A, 307, 307A 306, 306AL 305L, 305AL,	60.00
	D30004010	BEZEL	302, 302A, 301, 301A, 304, 304A, 303, 303A, 302L, 302AL 301L, 301AL,	100.00
	D30014010	BEZEL	306, 306A, 305, 305A 308, 308A, 307, 307A 306, 306AL 305L, 305AL,	120.00
	D30003000	POINTER SUB ASSY	302, 302A, 301, 301A, 304, 304A, 303, 303A, 302L, 302AL 301L, 301AL,	190.00
	D30013000	POINTER SUB ASSY	306, 306A, 305, 305A 308, 308A, 307, 307A 306, 306AL 305L, 305AL,	190.00
4	D30009031	DIAL		90.00
	D30009020	DIAL SPRING	302, 302A, 301, 301A, 304, 304A, 303, 303A, 302L, 302AL 301L, 301AL,	50.00
	D30019020	DIAL SPRING	306, 306A, 305, 305A 308, 308A, 307, 307A 306, 306AL 305L, 305AL,	70.00
6	U90120200	CHEESE HEAD SCREW M1.6 X 3	302, 302A, 301, 301A, 304, 304A, 303, 303A, 306, 306A, 305, 305A 308, 308A, 307, 307A 302L, 302AL 301L, 301AL, 306, 306AL 305L, 305AL,	30.00
7	D30002130	TOP PLATE	302, 302A, 301, 301A, 304, 304A, 303, 303A, 306, 306A, 305, 305A 308, 308A, 307, 307A 302L, 302AL 301L, 301AL, 306, 306AL 305L, 305AL,	30.00
8	D30009050	CHEESE HEAD SCREW M1.6 X 5	302, 302A, 301, 301A, 304, 304A, 303, 303A, 306, 306A, 305, 305A 308, 308A, 307, 307A 302L, 302AL 301L, 301AL, 306, 306AL 305L, 305AL,	30.00
	D30002020	CENTER PINION	302, 302A, 301, 301A, 306, 306A, 305, 305A 302L, 302AL 301L, 301AL, 306, 306AL 305L, 305AL,	120.00
	D34002020	CENTER PINION	304, 304A, 303, 303A, 308, 308A, 307, 307A	280.00
	D30002110	BEZEL BODY ASSY-ALPHA	302, 302A, 301, 301A, 306, 306A, 305, 305A 302L, 302AL 301L, 301AL, 306, 306AL 305L, 305AL,	210.00
	D34002110	BEZEL BODY ASSY-BETA	304, 304A, 303, 303A, 308, 308A, 307, 307A	700.00
11	D30019060	SPACER	306, 306A, 305, 305A 308, 308A, 307, 307A 306, 306AL 305L, 305AL,	90.00
	D30009040	BEZEL RETAINING C CLIP M300	302, 302A, 301, 301A, 304, 304A, 303, 303A, 302L, 302AL 301L, 301AL,	30.00
	D30019040	BEZEL RETAINING C CLIP M300	306, 306A, 305, 305A 308, 308A, 307, 307A 306, 306AL 305L, 305AL,	40.00
13	D30009010	BEZEL BODY SHIM	302, 302A, 301, 301A, 304, 304A, 303, 303A, 306, 306A, 305, 305A 308, 308A, 307, 307A 302L, 302AL 301L, 301AL, 306, 306AL 305L, 305AL,	50.00
	D30002200	BACKLASH SPINDLE & WHEEL ASSY	302, 302A, 301, 301A, 306, 306A, 305, 305A 302L, 302AL 301L, 301AL, 306, 306AL 305L, 305AL,	120.00
	D34002200	BACKLASH SPINDLE & WHEEL ASSY	304, 304A, 303, 303A, 308, 308A, 307, 307A	120.00

DIAL GAUGE SPARES



REF NO.	PART NO.	PART DESCRIPTION	USED ON	UNIT RATE ₹
15	D30002030	BACKLASH HAIR SPRING	302, 302A, 301, 301A, 304, 304A, 303, 303A, 306, 306A, 305, 305A 308, 308A, 307, 307A 302L, 302AL 301L, 301AL, 306, 306AL 305L, 305AL,	170.00
16	D30002010	BACKLASH SPRING RET CLIP	302, 302A, 301, 301A, 304, 304A, 303, 303A, 306, 306A, 305, 305A 308, 308A, 307, 307A 302L, 302AL 301L, 301AL, 306, 306AL 305L, 305AL,	40.00
17	D30001140	MAIN BODY SCREW 1.6 X 6LG	302, 302A, 301, 301A, 304, 304A, 303, 303A, 306, 306A, 305, 305A 308, 308A, 307, 307A 302L, 302AL 301L, 301AL, 306, 306AL 305L, 305AL,	30.00
18	D40529020	SLOTTED GRUB SCREW M1.6X4 LG.	304, 304A, 303, 303A, 308, 308A, 307, 307A 302L 302AL 301L, 301AL, 306, 306AL 305L, 305AL,	40.00
	D30001010	RETURN SPRING	302, 302A, 301, 301A, 306, 306A, 305, 305A 302L, 302AL 301L, 301AL, 306, 306AL 305L, 305AL,	40.00
	D34001010	RETURN SPRING	304, 304A, 303, 303A, 308, 308A, 307, 307A	50.00
20	D30001020	WASHER	302, 302A, 301, 301A, 304, 304A, 303, 303A, 306, 306A, 305, 305A 308, 308A, 307, 307A 302L, 302AL 301L, 301AL, 306, 306AL 305L, 305AL,	30.00
21	D30001030	CH.HD.SCREW-ALPHA	302, 302A, 301, 301A, 304, 304A, 303, 303A, 306, 306A, 305, 305A 308, 308A, 307, 307A 302L, 302AL 301L, 301AL, 306, 306AL 305L, 305AL,	40.00
	D30001500	FIRST PINION SUB ASSY	302, 302A, 301, 301A, 306, 306A, 305, 305A 302L, 302AL 301L, 301AL, 306, 306AL 305L, 305AL,	120.00
	D34001500	FIRST PINION SUB ASSY	304, 304A, 303, 303A, 308, 308A, 307, 307A	360.00
	D30031500	FIRST PINION SUB ASSY	302L, 302AL 301L, 301AL, 306, 306AL 305L, 305AL,	200.00
	D30001120	COVER	302, 302A, 301, 301A, 306, 306A, 305, 305A 302L, 302AL 301L, 301AL, 306, 306AL 305L, 305AL,	90.00
	D34001120	COVER	304, 304A, 303, 303A, 308, 308A, 307, 307A	100.00
	D30001700	JEWEL HOUSING ASSLY	302, 302A, 301, 301A, 306, 306A, 305, 305A 302L, 302AL 301L, 301AL, 306, 306AL 305L, 305AL,	120.00
	D30001600	BALL RACE ASSY	304, 304A, 303, 303A, 308, 308A, 307, 307A	280.00
25	D30001710	LOCKING RING	302, 302A, 301, 301A, 304, 304A, 303, 303A, 306, 306A, 305, 305A 308, 308A, 307, 307A 302L, 302AL 301L, 301AL, 306, 306AL 305L, 305AL,	70.00
26	D30001600	BALL RACE ASSY	302, 302A, 301, 301A, 304, 304A, 303, 303A, 306, 306A, 305, 305A 308, 308A, 307, 307A 302L, 302AL 301L, 301AL, 306, 306AL 305L, 305AL,	280.00
27	D30001320	LEVER	302, 302A, 301, 301A, 304, 304A, 303, 303A, 306, 306A, 305, 305A 308, 308A, 307, 307A 302L, 302AL 301L, 301AL, 306, 306AL 305L, 305AL,	300.00
	D30001330	STYLUS SPINDLE	302, 302A, 301, 301A, 306, 306A, 305, 305A	450.00
	D34001330	STYLUS SPINDLE	304, 304A, 303, 303A, 308, 308A, 307, 307A, 302L, 302AL 301L, 301AL, 306, 306AL 305L, 305AL,	450.00
29	D30001350	SLOTTED HEAD GRUB SCREW	302, 302A, 301, 301A, 306, 306A, 305, 305A	20.00
30	D30001340	BUSH FOR STYLUS SPINDLE	302, 302A, 301, 301A, 306, 306A, 305, 305A	40.00
31	D30039940	EXTENSION FOR STYLUS	302L, 302AL 306, 306AL	120.00
	D32039940	EXTENSION FOR STYLUS	301L, 301AL, 305L, 305AL,	120.00
32	D30009935	STYLUS 1MM CARBIDE	302306, 306A, 302L306, 306A, L	480.00
	D30009934	STYLUS 2MM CARBIDE	302306, 306A, 302L306, 306A, L	650.00
	D32009935	STYLUS 1MM CARBIDE	301, 301A, 305, 305A 301L, 301AL, 305L, 305AL,	380.00
	D32009934	STYLUS 2MM CARBIDE	301, 301A, 305, 305A 301L, 301AL, 305L, 305AL,	330.00
	D34009935	STYLUS 1MM CARBIDE	304, 304A, 308, 308A,	380.00
	D34009934	STYLUS 2MM CARBIDE	304, 304A, 308, 308A,	380.00
	D35009935	STYLUS 1MM CARBIDE	303, 303A, 307, 307A	380.00
	D35009934	STYLUS 2MM CARBIDE	303, 303A, 307, 307A	380.00

DIAL GAUGE SPARES

REF NO.	PART NO.	PART DESCRIPTION	USED ON	UNIT RATE ₹
33	D30001400	SEGMENT SPINDLE SUB ASSY	302, 302A, 301, 301A, 306,306A,305, 305A	250.00
	D34001400	SEGMENT SPINDLE SUB ASSY	304, 304A, 303, 303A, 308,308A, 307, 307A	490.00
	D30031400	SEGMENT SPINDLE SUB ASSY	302L,302AL 301L, 301AL, 306,306AL 305L, 305AL,	330.00
34	D30001110	MAIN BODY	302, 302A, 301, 301A, 306,306A,305, 305A	590.00
	D34001110	MAIN BODY	304, 304A, 303, 303A, 308,308A, 307, 307A	650.00
	D30031110	MAIN BODY	302L,302AL 301L, 301AL, 306,306AL 305L, 305AL,	650.00
35	D30001140	MAIN BODY SCREW 1.6 X 6LG	302, 302A, 301, 301A, 304, 304A, 303, 303A, 306, 306A,305, 305A 308,308A, 307, 307A 302L,302AL 301L, 301AL, 306,306AL 305L, 305AL,	30.00
36	D37001003	UNIVERSAL CLAMP ASSY 8MM	302, 302A, 301, 301A, 304, 304A, 303, 303A, 306, 306A,305, 305A 308,308A, 307, 307A 302L,302AL 301L, 301AL, 306,306AL 305L, 305AL,	420.00
37	D37002001	HT. GAUGE ADAPTOR ASSLY LOCAL	302, 302A, 301, 301A, 304, 304A, 303, 303A, 306,306A,305, 305A 308,308A, 307, 307A 302L, 302AL 301L, 301AL, 306,306AL 305L, 305AL,	300.00
38	D37003010	SPIGOT DIA 8MM	302, 302A, 301, 301A, 304, 304A, 303, 303A, 306,306A,305, 305A 308,308A, 307, 307A 302L, 302AL 301L, 301AL, 306,306AL 305L, 305AL,	280.00
39	D37003014	SPIGOT DIA 4MM	302, 302A, 301, 301A, 304, 304A, 303, 303A, 306,306A,305, 305A 308,308A, 307, 307A 302L, 302AL 301L, 301AL, 306,306AL 305L, 305AL,	280.00
40	D37003020	DOVETAIL	302, 302A, 301, 301A, 304, 304A, 303, 303A, 306,306A,305, 305A 308,308A, 307, 307A 302L, 302AL 301L, 301AL, 306,306AL 305L, 305AL,	80.00
41	D30009983	SPANNER	302, 302A, 301, 301A, 304, 304A, 303, 303A, 306,306A,305, 305A 308,308A, 307, 307A 302L, 302AL 301L, 301AL, 306,306AL 305L, 305AL,	20.00

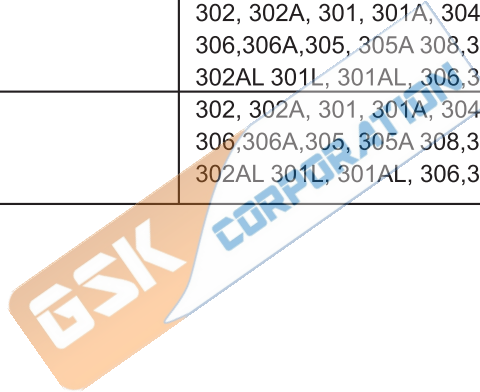

CALIPERS



DIGITAL CALIPERS

PRODUCT CODE	DESCRIPTION	UNIT RATE ₹
E62219000	BAKER Water Resistant Digital Caliper Type ZDN10 , with metric & inch capability and RS232 data output, conforming to IP67. Reading : 0.01 mm / 0.0005 inch Range : 0 - 150 mm / 0 - 6 inch	12,600.00
E62229000	BAKER Water Resistant Digital Caliper Type ZDN20 , with metric & inch capability and RS232 data output, conforming to IP67. Reading : 0.01 mm / 0.0005 inch Range : 0 - 200 mm / 0 - 8 inch	15,790.00
E62239000	BAKER Water Resistant Digital Caliper Type ZDN30 , with metric & inch capability and RS232 data output, conforming to IP67. Reading : 0.01 mm / 0.0005 inch Range : 0 - 300 mm / 0 - 12 inch	19,450.00
XE62211005	BAKER Proximity Cable for RS232 interface suitable for BAKER ZDN series IP67 Digital Calipers	9,090.00
XE62211004	BAKER Proximity Cable for USB interface suitable for BAKER ZDN series IP67 Digital Calipers	9,920.00
E62189000	BAKER Digital Caliper Type SDN10 , with metric & inch capability. Reading : 0.01 mm / 0.0005 inch Range : 0 - 150 mm / 0 - 6 inch	6,970.00
E62199000	BAKER Digital Caliper Type SDN20 , with metric & inch capability. Reading : 0.01 mm / 0.0005 inch Range : 0 - 200 mm / 0 - 8 inch	9,080.00
E62209000	BAKER Digital Caliper Type SDN30 , with metric & inch capability. Reading : 0.01 mm / 0.0005 inch Range : 0 - 300 mm / 0 - 12 inch	11,790.00
E62319000	BAKER Large Diameter Digital Caliper Type SDN50 , with metric & inch capability. Reading : 0.01 mm / 0.0005 inch Range : 0 - 500 mm / 0 - 20 inch	27,600.00
E62329000	BAKER Large Diameter Digital Caliper Type SDN60 , with metric & inch capability. Reading : 0.01 mm / 0.0005 inch Range : 0 - 600 mm / 0 - 24 inch	32,500.00
E62339000	BAKER Large Diameter Digital Caliper Type SDN80 , with metric & inch capability. Reading : 0.01 mm / 0.0005 inch Range : 0 - 800 mm / 0 - 32 inch	58,255.00
E62349000	BAKER Large Diameter Digital Caliper Type SDN100 , with metric & inch capability. Reading : 0.01 mm / 0.0005 inch Range : 0 - 1000 mm / 0 - 40 inch	67,100.00
E63159000	BAKER Digital Caliper Type SDN150 , with metric & inch capability. Reading : 0.01 mm / 0.0005 inch Range : 0 - 1500 mm / 0 - 60 inch	1,32,600.00
E63169000	BAKER Digital Caliper Type SDN200 , with metric & inch capability. Reading : 0.01 mm / 0.0005 inch Range : 0 - 2000 mm / 0 - 80 inch	1,91,360.00
E64019000	BAKER Digital Caliper Type ED10 , with metric & inch capability. Reading : 0.01 mm / 0.0005 inch Range : 0 - 150 mm / 0 - 6 inch	3,840.00
E64029000	BAKER Digital Caliper Type ED20 , with metric & inch capability. Reading : 0.01 mm / 0.0005 inch Range : 0 - 200 mm / 0 - 8 inch	5,780.00
E64039000	BAKER Digital Caliper Type ED30 , with metric & inch capability. Reading : 0.01 mm / 0.0005 inch Range : 0 - 300 mm / 0 - 12 inch	7,810.00

DIGITAL DEPTH CALIPERS

E71009000	BAKER Digital Depth Caliper Type DDC10 , with metric & inch capability. Reading : 0.01 mm / 0.0005 inch Range : 0 - 150 mm / 0 - 6 inch	5,190.00
E72009000	BAKER Digital Depth Caliper Type DDC20 , with metric & inch capability. Reading : 0.01 mm / 0.0005 inch Range : 0 - 200 mm / 0 - 8 inch	6,350.00
E73009000	BAKER Digital Depth Caliper Type DDC30 , with metric & inch capability. Reading : 0.01 mm / 0.0005 inch Range : 0 - 300 mm / 0 - 12 inch	11,660.00

VERNIER DEPTH CALIPERS

PRODUCT CODE	DESCRIPTION	UNIT RATE ₹
D90129000	BAKER Vernier Depth Caliper Type VDC10. Reading : 0.02 mm Range : 0-150 mm / 0-6 inch	2,650.00
D90139000	BAKER Vernier Depth Caliper Type VDC20. Reading : 0.02 mm Range : 0-200 mm / 0-8 inch	3,120.00
D90149000	BAKER Vernier Depth Caliper Type VDC30. Reading : 0.02 mm Range : 0-300 mm / 0-12 inch	5,030.00

D93069000	BAKER Internal Groove Caliper Type IGC10 Reading : 0.010 mm Range : 10-120 mm	20,770.00
-----------	--	-----------

DIAL CALIPERS

PRODUCT CODE	DESCRIPTION	UNIT RATE ₹
D85049000	BAKER Dial Caliper Type DC10 with adjustable Bezel. Reading : 0.02 mm Range : 0 - 150 mm	3,770.00
D85059000	BAKER Dial Caliper Type DC20 with adjustable Bezel. Reading : 0.02 mm Range : 0 - 200 mm	6,320.00
D85069000	BAKER Dial Caliper Type DC30 with adjustable Bezel. Reading : 0.02 mm Range : 0 - 300 mm	8,410.00

VERNIER CALIPERS

PRODUCT CODE	DESCRIPTION	UNIT RATE ₹
D85079000	BAKER Vernier Caliper Type VC10 with metric & inch capability Reading : 0.02 mm / 0.001 inch Range : 0 - 150 mm / 0 - 6 inch	2,160.00
D85089000	BAKER Vernier Caliper Type VC20 with metric & inch capability Reading : 0.02 mm / 0.001 inch Range : 0 - 200 mm / 0 - 8 inch	3,220.00
D85099000	BAKER Vernier Caliper Type VC30 with metric & inch capability Reading : 0.02 mm / 0.001 inch Range : 0 - 300 mm / 0 - 12 inch	6,430.00
D85019000	BAKER Vernier Caliper Type VCF10 with fine adjustment and metric & inch capability Reading : 0.02 mm / 0.001 inch Range : 0 - 130 mm / 0 - 5 inch	2,430.00
D85029000	BAKER Vernier Caliper Type VCF20 with fine adjustment and metric & inch capability Reading : 0.02 mm / 0.001 inch Range : 0 - 180 mm / 0 - 7 inch	3,590.00

CALIPERS

VERNIER CALIPERS

PRODUCT CODE	DESCRIPTION	UNIT RATE ₹
D85039000	BAKER Vernier Caliper Type VCF30 with fine adjustment and metric & inch capability Reading : 0.02 mm / 0.001 inch Range : 0 - 280 mm / 0 - 11 inch	6,710.00
D85109000	BAKER Vernier Caliper Type VCF45 with fine adjustment and metric & inch capability Reading : 0.02 mm / 0.001 inch Range : 0 - 430 mm / 0 - 17 inch	18,850.00
D85119000	BAKER Vernier Caliper Type VCF60 with fine adjustment and metric & inch capability Reading : 0.02 mm / 0.001 inch Range : 0 - 580 mm / 0 - 23 inch	21,880.00
D85129000	BAKER Vernier Caliper Type VCF80 with fine adjustment and metric & inch capability Reading : 0.02 mm / 0.001 inch Range : 0 - 780 mm / 0 - 31 inch	36,240.00
D85139000	BAKER Vernier Caliper Type VCF100 with fine adjustment and metric & inch capability Reading : 0.02 mm / 0.001 inch Range : 0 - 980 mm / 0 - 39 inch	47,210.00
D85249000	BAKER Vernier Caliper Type VCF150 with fine adjustment and metric & inch capability Reading : 0.02 mm / 0.001 inch Range : 0 - 1500 mm / 0 - 60 inch	87,000.00
D85259000	BAKER Vernier Caliper Type VCF200 with fine adjustment and metric & inch capability Reading : 0.02 mm / 0.001 inch Range : 0 - 2000 mm / 0 - 80 inch	1,52,900.00

DOUBLE INSIDE GROOVE DIGITAL CALIPER

PRODUCT CODE	DESCRIPTION	UNIT RATE ₹
E65019000	BAKER DOUBLE INSIDE GROOVE DIGITAL CALIPER TYPE DGC10 Upper Jaw : 9-150 mm / 0.35 - 6" Lower Jaw : 17-150 mm / 0.70 - 6"	14,960.00

BAKER INTERNAL DIAL CALIPERS

PRODUCT CODE	DESCRIPTION	UNIT RATE ₹
D95259000	BAKER Internal Dial Caliper Gauge Type IDC15 Reading : 0.01 mm Range : 5-15 mm	13,170.00
D95269000	BAKER Internal Dial Caliper Gauge Type IDC25 Reading : 0.01 mm Range : 5-25 mm	14,270.00
D95279000	BAKER Internal Dial Caliper Gauge Type IDC30 Reading : 0.01 mm Range : 10-30 mm	15,750.00
D95289000	BAKER Internal Dial Caliper Gauge Type IDC40 Reading : 0.01 mm Range : 20-40 mm	17,360.00
D95299000	BAKER Internal Dial Caliper Gauge Type IDC50 Reading : 0.01 mm Range : 30-50 mm	18,980.00

DIGITAL HEIGHT GAUGES

PRODUCT CODE	DESCRIPTION	UNIT RATE ₹
E63029000	BAKER Feed Wheel Type Digital Height Gauge Type DH300 with metric & inch capability, supplied with tungsten carbide tipped scriber. Reading : 0.01 mm / 0.0005 inch Range : 0 - 300 mm / 0 - 12 inch	27,060.00
E63039000	BAKER Feed Wheel Type Digital Height Gauge Type DH600 with metric & inch capability, supplied with tungsten carbide tipped scriber. Reading : 0.01 mm / 0.0005 inch Range : 0 - 600 mm / 0 - 24 inch	49,710.00
E62049000	BAKER Digital Height Gauge Type DH1000 with metric & inch capability, supplied with tungsten carbide tipped scriber. Reading : 0.01 mm / 0.0005 inch Range : 0 - 1000 mm / 0 - 40 inch	80,740.00

VERNIER HEIGHT GAUGES

PRODUCT CODE	DESCRIPTION	UNIT RATE ₹
D90049000	BAKER Vernier Height Gauge Type VH300 mm with metric & inch capability, supplied with tungsten carbide tipped scriber and magnifying glass Reading : 0.02 mm / 0.001 inch Range : 0 - 300 mm / 0 - 12 inch	15,990.00
D90059000	BAKER Vernier Height Gauge Type VH600 mm with metric & inch capability, supplied with tungsten carbide tipped scriber and magnifying glass Reading : 0.02 mm / 0.001 inch Range : 0 - 600 mm / 0 - 24 inch	27,140.00
E63069000	BAKER Double Column Digital Height Gauge Type DCDH300 . Reading : 0.010 mm/0.0005" Range : 0-300 mm/0-12"	38,120.00
E63099000	BAKER Double Column Digital Height Gauge Type DCDH600 Reading : 0.010 mm/0.0005" Range : 0-600 mm/0-24"	57,170.00

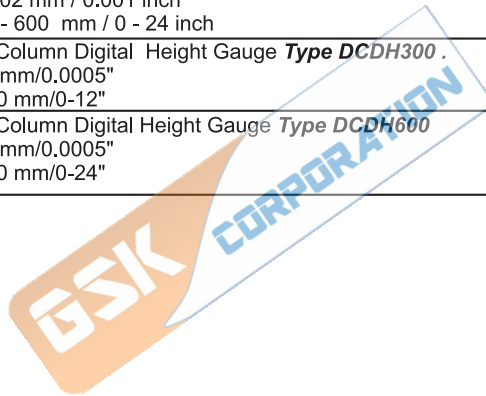

DIGITAL HEIGHT GAUGES



2D HEIGHT GAUGES

PRODUCT CODE	DESCRIPTION	UNIT RATE ₹
E63279000	2D Height Gauge - PROHEIGHT 400 Reading : 0.01/0.005/0.001/0.0005/0.0001 mm Range : 0 - 450 mm	2,35,000.00
E63269000	2D Height Gauge - PROHEIGHT 400P Reading : 0.01/0.005/0.001/0.0005/0.0001 mm Range : 0 - 450 mm	3,35,000.00
E63319000	2D Height Gauge - PROHEIGHT 700 Reading : 0.01/0.005/0.001/0.0005/0.0001 mm Range : 0 - 700 mm	2,80,000.00
E63259000	2D Height Gauge - PROHEIGHT 700P Reading : 0.01/0.005/0.001/0.0005/0.0001 mm Range : 0 - 700 mm	3,80,000.00
E63249000	2D Height Gauge - PROHEIGHT 1000 Reading : 0.01/0.005/0.001/0.0005/0.0001 mm Range : 0 - 1000 mm	3,30,000.00
E63239000	2D Height Gauge - PROHEIGHT 1000P Reading : 0.01/0.005/0.001/0.0005/0.0001 mm Range : 0 - 1000 mm	4,30,000.00

SURFACE ROUGHNESS TESTER

E63089000	BAKER Portable Surface Roughness Tester SRT200	1,15,500.00
-----------	--	-------------

UNIVERSAL BEVEL PROTRACTOR

D88019000	BAKER Precision Universal Bevel Protractor	6,590.00
-----------	--	----------

PRECISION SPIRIT LEVEL

PRODUCT CODE	DESCRIPTION	UNIT RATE ₹
D89409000	Spirit Level Type BSL 150 (150 x 0.02 mm)	9,890.00
D89419000	Spirit Level Type BSL 200 (200 x 0.02 mm)	10,340.00
D89429000	Spirit Level Type BSL 300 (300 x 0.02 mm)	12,870.00

SLIP GAUGES - STEEL AND CARBIDE

PRODUCT CODE	DESCRIPTION	UNIT RATE ₹
D89259000	Slip Gauge Set - Steel M112/1 in Grade-0 (112 Pcs set)	Price on Request
D89279000	Slip Gauge Set - Steel M112/1 in Grade-1 (112 Pcs set)	
D89299000	Slip Gauge Set - Steel M83 in Grade-2 (83 Pcs set)	
D89269000	Slip Gauge Set - Carbide M112/1 in Grade-0 (112 Pcs set)	
D89289000	Slip Gauge Set - Carbide M112/1 in Grade-1 (112 Pcs set)	

ELECTRONIC PROBES

PRODUCT CODE	DESCRIPTION	UNIT RATE ₹
E44059000	BAKER Electronic Axial Probe Type 2940 Half-Bridge type inductive probe with 2 Mtr. Length Polyurethane Cable and with Tungsten Carbide Ball Anvil. Range : ± 2mm	13,200.00
E44099000	BAKER Electronic Axial Probe with Right Angle Cap Type 2940R Half-Bridge type inductive probe with 2 Mtr. Length Polyurethane Cable and with Tungsten Carbide Ball Anvil. Range : ± 2mm	13,200.00
E41229000	BAKER Electronic Vacuum Retract Axial Probe Type 2940V Half-Bridge type inductive probe with 2 Mtr. Length Polyurethane Cable and with Tungsten Carbide Ball Anvil. Range : ± 2mm	18,470.00
E41289000	BAKER Electronic Short Body (60mm) Axial Probe Type 2910 Half-Bridge type inductive probe with 2 Mtr. Length Polyurethane Cable and with Tungsten Carbide Ball Anvil. Range : ± 0.5mm	15,860.00
E41329000	BAKER Electronic Axial Probe Type 2940L LVDT type inductive probe with 2 Mtr. Length Polyurethane Cable and with Tungsten Carbide Ball Anvil. Range : ± 2mm	13,200.00
E41369000	BAKER Electronic Axial Probe with Right Angle Cap Type 2940RL LVDT type inductive probe with 2 Mtr. Length Polyurethane Cable and with Tungsten Carbide Ball Anvil. Range : ± 2mm	13,200.00
E41349000	BAKER Electronic Vacuum Retract Axial Probe Type 2940VL LVDT type inductive probe with 2 Mtr. Length Polyurethane Cable and with Tungsten Carbide Ball Anvil. Range : ± 2mm	18,470.00
E41379000	BAKER Electronic Short Body (60mm) Axial Probe Type 2910L LVDT type inductive probe with 2 Mtr. Length Polyurethane Cable and with Tungsten Carbide Ball Anvil. Range : ± 1mm	15,860.00
E44009000	BAKER Electronic Axial Probe Model 2920 with 2 meter cable Range :± 1mm	13,200.00

PROBES AND TOOLS

PRODUCT CODE	DESCRIPTION	UNIT RATE ₹
D92539000	3D TESTER	21,040.00
D92549000	EDGE FINDER OPTICAL	12,320.00
D92569000	ZERO SETTER 100 MM MECHANICAL (WITH MAGNET)	19,360.00
D92579000	ZERO SETTER 60 MM OPTICAL (WITH MAGNET)	18,850.00
D92559000	COAXIAL INDICATOR CENTRE PLUS V2 DIA 0 - DIA110 (WITHOUT DIAL GAUGE)	12,620.00

NDT INSTRUMENTS

PRODUCT CODE	DESCRIPTION	UNIT RATE ₹
E70329000	DIGITAL COATING THICKNESS TESTER (CTG-P)	88,000.00
E70369000	DIGITAL COATING THICKNESS TESTER (CTG-E)	33,100.00
E70319000	DIGITAL SHORE HARDNESS TESTER EHS-1A / ID	46,100.00
E70339000	ULTRASONIC THICKNESS TESTER (UTG - 300)	33,100.00
E70349000	ULTRASONIC AND LEEB TYPE HARDNESS TESTER (ULHT)	4,95,000.00
E70359000	DIGITAL FORCE GAUGE (DFG 500) RANGE 500N	46,100.00

MASTER SETTING RINGS

NOMINAL DIAMETER RANGE						UNIT RATE ₹
MM			INCH			
Above	Upto & Including		Above	Upto & Including		
1.5	-	2.5	0.06	-	0.10	4190.00
2.5	-	5.0	0.10	-	0.20	2730.00
5.0	-	20.0	0.20	-	0.79	1860.00
20.0	-	40.0	0.79	-	1.57	1920.00
40.0	-	60.0	1.57	-	2.36	2170.00
60.0	-	80.0	2.36	-	3.15	3360.00
80.0	-	100.0	3.15	-	3.94	4560.00
100.0	-	120.0	3.94	-	4.72	5690.00
120.0	-	140.0	4.72	-	5.51	7010.00
140.0	-	150.0	5.51	-	5.90	8340.00
150.0	-	160.0	5.90	-	6.30	10110.00
160.0	-	170.0	6.30	-	6.70	11880.00
170.0	-	180.0	6.70	-	7.09	12700.00
180.0	-	190.0	7.09	-	7.48	14250.00
190.0	-	200.0	7.48	-	7.87	15150.00
200.0	-	212.0	7.87	-	8.35	18960.00
212.0	-	224.0	8.35	-	8.82	21460.00
224.0	-	236.0	8.82	-	9.29	27660.00
236.0	-	250.0	9.29	-	9.84	30360.00
250.0	-	265.0	9.84	-	10.43	37980.00
265.0	-	280.0	10.43	-	11.02	43080.00
280.0	-	300.0	11.02	-	11.81	48660.00
300.0	-	315.0	11.81	-	12.40	55160.00
315.0	-	325.0	12.40	-	12.80	68100.00
325.0	-	340.0	12.80	-	13.39	74050.00
340.0	-	350.0	13.39	-	13.78	77160.00
350.0	-	360.0	13.78	-	14.17	87890.00
360.0	-	370.0	14.17	-	14.57	111470.00
370.0	-	380.0	14.57	-	14.96	113980.00
380.0	-	390.0	14.96	-	15.35	119610.00
390.0	-	400.0	15.35	-	15.75	124480.00
400.0	-	410.0	15.75	-	16.14	142750.00
410.0	-	420.0	16.14	-	16.54	145490.00
420.0	-	430.0	16.54	-	16.93	154040.00
430.0	-	440.0	16.93	-	17.32	156870.00
440.0	-	450.0	17.32	-	17.72	162790.00
450.0	-	460.0	17.72	-	18.11	185060.00
460.0	-	470.0	18.11	-	18.50	191640.00
470.0	-	480.0	18.50	-	18.90	195900.00
480.0	-	490.0	18.90	-	19.29	210300.00
490.0	-	500.0	19.29	-	19.69	213660.00

- "Certificate of Inspection" is provided with each gauge, traceable to National/International Length Standards.
- For NABL (National Accreditation Board for Testing & Calibration Laboratories) Certification, extra charges will be applicable, which can be made available on request. For NABL Scope of Accreditation, please refer page 27 & 28

Technical Notes :

1. Master Setting Rings will be manufactured as per DIN - 2250C.
2. Technical supply conditions as per DIN 2239, with surface finish as per Class - I.
3. Made from Oil Hardening Non-Shrinking Gauge Steel Hardened & Tempered to 700 HV.
4. Sub-zero treated at -80° C for dimensional stability.
5. Calibrated at 20° C under Standards Room conditions.
6. Actual dimensions duly etched.

NOMINAL DIAMETER RANGE					UNIT RATE ₹	
MM			INCH			
Above	Upto & Including		Above	Upto & Including		
5.0	-	10.0	0.12	-	0.39	4310.00
10.0	-	15.0	0.39	-	0.59	3450.00
15.0	-	20.0	0.59	-	0.79	3450.00
20.0	-	25.0	0.79	-	0.98	5170.00
25.0	-	32.0	0.98	-	1.26	6170.00
32.0	-	40.0	1.26	-	1.57	7610.00
40.0	-	50.0	1.57	-	1.97	7830.00
50.0	-	60.0	1.97	-	2.36	13530.00
60.0	-	70.0	2.36	-	2.76	14910.00
70.0	-	80.0	2.76	-	3.15	16290.00
80.0	-	90.0	3.15	-	3.54	17890.00
90.0	-	100.0	3.54	-	3.94	19510.00

MASTER SETTING DISCS

NOMINAL DIAMETER RANGE					UNIT RATE ₹	
MM			INCH			
Above	Upto & Including		Above	Upto & Including		
3.0	-	10.0	0.12	-	0.39	1460.00
10.0	-	24.0	0.39	-	0.95	1110.00
24.0	-	40.0	0.95	-	1.58	1310.00
40.0	-	65.0	1.58	-	2.56	1510.00
65.0	-	80.0	2.56	-	3.15	1740.00
80.0	-	100.0	3.15	-	3.94	2040.00
100.0	-	120.0	3.94	-	4.72	2510.00
120.0	-	140.0	4.72	-	5.51	3590.00
140.0	-	150.0	5.51	-	5.90	4670.00
150.0	-	160.0	5.90	-	6.30	5400.00
160.0	-	175.0	6.30	-	6.89	5960.00
175.0	-	190.0	6.89	-	7.48	6830.00
190.0	-	200.0	7.48	-	7.87	7870.00

- "Certificate of Inspection" is provided with each gauge, traceable to National/International Length Standards.
- For NABL (National Accreditation Board for Testing & Calibration Laboratories) Certification, extra charges will be applicable, which can be made available on request. For NABL Scope of Accreditation, please refer page 27 & 28

Technical Notes :

1. The Gauge blanks will be as per ANSI-B47.1 - 1988.
2. Tolerances followed as per Class - X of ASME B89.1.5 - 1998.
3. Made from Oil Hardening Non-Shrinking Gauge Steel Hardened & Tempered to 700 HV.
4. Sub-zero treated at -80° C for dimensional stability.
5. Calibrated at 20° C under Standards Room conditions.
6. Actual dimensions duly.

TERMS & CONDITIONS (for products)

1. PRICE : Ex-Works, Pune.
2. PACKING & FORWARDING : EXTRA @ 3%
3. GST : Extra as applicable.
4. PAYMENT : 25% Advance alongwith order and balance against Proforma Invoice.
5. DESPATCH : Courier Service.
6. FREIGHT : Extra at Actual.
7. INSURANCE : To be arranged by you.
8. This price list is subject to alteration without any notice & cancels all our previous price lists.

MEASURING PIN SETS

0.01mm STEPS (WITHOUT KNOB)

RANGE	NO OF PINS	₹
0.50-0.99mm	50	9,800
1.00-2.00mm	101	14,600
2.01-3.00mm	100	13,700
3.01-4.00mm	100	12,300
4.01-5.00mm	100	12,900
5.01-6.00mm	100	13,900
6.01-7.00mm	100	14,400
7.01-8.00mm	100	14,600
8.01-9.00mm	100	15,100
9.01-10.00mm	100	15,700
10.01-11.00mm	100	16,100
11.01-12.00mm	100	16,700
12.01-13.00mm	100	18,300
13.01-14.00mm	100	19,400
14.01-15.00mm	100	20,700
15.01-16.00mm	100	21,900
16.01-16.75mm	75	20,400
16.76-17.50mm	75	21,400
17.51-18.25mm	75	22,200
18.26-19.00mm	75	23,400
19.01-19.50mm	50	17,400
19.51-20.00mm	50	18,600

0.02mm STEPS (WITHOUT KNOB)

RANGE	NO OF PINS	₹
0.50-1.00mm	26	6,000
1.02-3.00mm	100	14,200
3.02-5.00mm	100	13,200
5.02-7.00mm	100	14,200
7.02-10.00mm	150	22,200
10.02-12.00mm	100	16,100
12.02-14.00mm	100	18,800
14.02-16.00mm	100	21,300
16.02-17.50mm	75	21,000
17.52-19.00mm	75	22,700
19.02-20.00mm	50	18,000

0.05mm STEPS (WITHOUT KNOB)

RANGE	NO OF PINS	₹
0.50-2.00mm	31	7,700
2.05-7.00mm	100	16,700
7.05-12.00mm	100	19,000
12.05-15.00mm	60	14,700
15.05-18.00mm	60	18,800
18.05-20.00mm	40	15,900

TERMS & CONDITIONS (for products)

1. PRICE : Ex-Works, Pune.
2. PACKING & FORWARDING : EXTRA @ 3%
3. GST : Extra as applicable.
4. PAYMENT : 25% Advance alongwith order and balance against Proforma Invoice.
5. DESPATCH : Courier Service.
6. FREIGHT : Extra at Actual.
7. INSURANCE : To be arranged by you.
8. This price list is subject to alteration without any notice & cancels all our previous price lists.

CALIBRATION CHARGES

- Calibration Charges mentioned below (Page 32 to 34) are for providing our standard Certificate of Calibration with each gauge traceable to National / International Length Standards.
- However, for providing NABL (National Accreditation Board for Testing & Calibration Laboratories) Certification (which can be made available on request), 25% extra charges will be applicable on the charges mentioned below.
- For economical transaction we need a minimum order value of Rs. 500/-. Hence for order value of less than Rs. 500/-, Handling charges of Rs. 250/- will be applicable extra.

CALIBRATION CHARGES FOR MASTER SETTING RINGS

NOMINAL DIAMETER RANGE						UNIT RATE ₹
MM			INCH			
Above	Upto & Including		Above	Upto & Including		
1.0	-	1.5	0.04	-	0.06	460.00
1.5	-	6.0	0.06	-	0.24	330.00
6.0	-	30.0	0.24	-	1.18	310.00
30.0	-	60.0	1.18	-	2.36	430.00
60.0	-	80.0	2.36	-	3.15	550.00
80.0	-	100.0	3.15	-	3.94	660.00
100.0	-	120.0	3.94	-	4.72	730.00
120.0	-	200.0	4.72	-	7.87	910.00
200.0	-	315.0	7.87	-	12.40	1,460.00

CALIBRATION CHARGES FOR MASTER SETTING DISCS / PLAIN PLUG GAUGES

NOMINAL DIAMETER RANGE						UNIT RATE ₹
MM			INCH			
Above	Upto & Including		Above	Upto & Including		
1.0	-	65.0	0.04	-	2.56	310.00
65.0	-	100.0	2.56	-	3.94	430.00
100.0	-	200.0	3.94	-	7.87	610.00

CALIBRATION CHARGES FOR PLAIN TAPER GAUGES (MALE / FEMALE)

NOMINAL DIAMETER RANGE						UNIT RATE ₹
MM			INCH			
Above	Upto & Including		Above	Upto & Including		
4.0	-	25.0	0.16	-	0.98	1,460.00
25.0	-	50.0	0.98	-	1.97	2,060.00
50.0	-	75.0	1.97	-	2.95	3,030.00
75.0	-	100.0	2.95	-	3.94	3,880.00
100.0	-	120.0	3.94	-	4.72	4,480.00

- Calibration of Plain Taper Gauges will be done at two levels (Major & Minor Dias.)
- Internal taper measurement will be done upto diameter 100mm only.
- Internal taper calibration is not covered under NABL Accreditation.
- Calibration charges External / Internal Taper Gauges above size 120mm can be quoted on request.

CALIBRATION CHARGES

CALIBRATION CHARGES FOR ROUNDNESS MEASUREMENT (INTERNAL & EXTERNAL DIAMETERS)

NOMINAL DIAMETER RANGE						UNIT RATE ₹
MM			INCH			
Above	Upto & Including		Above	Upto & Including		
3.0	-	315.0	0.12	-	12.40	2420.00

- Maximum weight of the Master should not exceed 18 Kgs.
- Roundness will be checked at one level. If roundness is required at more than one level, charges will be 25% extra of the basic charge per level.

CALIBRATION CHARGES FOR ROUNDNESS MASTERS

DESCRIPTION	UNIT RATE ₹
ROUNDNESS MASTERS	2420.00

CALIBRATION CHARGES FOR SURFACE FINISH MEASUREMENT / ROUGHNESS MASTERS

DESCRIPTION	UNIT RATE ₹
ROUGHNESS MASTER (UPTO 0.006MM Ra, ONLY UNDER NABL)	1820.00 Per Surface
SURFACE ROUGHNESS MEASUREMENT	610.00 Per Parameter

CALIBRATION CHARGES FOR DIAL GAUGES

DESCRIPTION	UNIT RATE ₹
PLUNGER TYPE DIAL GAUGES	250.00
LEVER TYPE DIAL GAUGES	490.00
DIAL BORE GAUGES (18 - 300 mm)	850.00
DIAL THICKNESS GAUGES	250.00

CALIBRATION CHARGES FOR ELECTRONIC PRODUCTS

DESCRIPTION	UNIT RATE ₹
TWIN CHANNEL ELECTRONIC COMPARATOR.	2,730.00
SINGLE CHANNEL ELECTRONIC COMPARATOR.	1,820.00

CALIBRATION CHARGES FOR DIGITAL DIAL GAUGES

DESCRIPTION	UNIT RATE ₹
DIGITAL DIAL GAUGES	
Range : 12.5 mm	610.00
Range : 25.0 mm	910.00
Range : 50.0 mm	1,210.00

CALIBRATION CHARGES FOR DIGITAL CALIPERS / DIAL CALIPERS / VERNIER CALIPERS

DESCRIPTION	UNIT RATE ₹
DIGITAL CALIPERS / DIAL CALIPERS / VERNIER CALIPERS	
Range : 0 - 150 mm	610.00
Range : 0 - 200 mm	610.00
Range : 0 - 300 mm	730.00

CALIBRATION CHARGES FOR BAKER HEIGHT GAUGES (WITH NABL ACCREDITATION CERTIFICATE)

DESCRIPTION	UNIT RATE ₹
BAKER HEIGHT GAUGES	
Baker Digital Height Gauge - Type DH 300	1050.00
Baker Digital Height Gauge - Type DH 600	1380.00
Baker Vernier Height Gauge - Type VH 300	1050.00
Baker Vernier Height Gauge - Type VH 600	1380.00

CALIBRATION CHARGES FOR THREE POINT MICROMETERS (WITH NABL ACCREDITATION CERTIFICATE)

DESCRIPTION	UNIT RATE ₹
Range : 6 - 25 mm	1,030.00
Range : 25 - 50 mm	1,210.00
Range : 50 - 100 mm	1,460.00
Range : 100 - 200 mm	1,820.00
Range : 200 - 300 mm	3,030.00

CALIBRATION CHARGES FOR SLIP GAUGES

DESCRIPTION	UNIT RATE ₹
SLIP GAUGE CALIBRATION RANGE 0.5 TO 100 MM (METRIC ONLY)	90.00 EACH SLIP

TERMS & CONDITIONS (for services)

1. PRICE : Ex-Works, Pune.
2. PACKING & FORWARDING : Extra as applicable.
3. DESPATCH : Courier Service / Speed Post.
4. FREIGHT : Extra at Actual.
5. GST : Extra as applicable.
6. PAYMENT : Full payment to be made along with order / against proforma Invoice.
7. INSURANCE : To be arranged by you.
8. This price list is subject to alteration without any notice & cancels all our previous price lists.

BAKER GAUGES INDIA PRIVATE LIMITED

HEAD OFFICE & FACTORY

37 - 40, NAGAR ROAD, PUNE - 411 014

HIP DIVISION



BAKER

...a passion for precision

HIP DIVISION PRICE LIST

Page Nos. 48 to 86

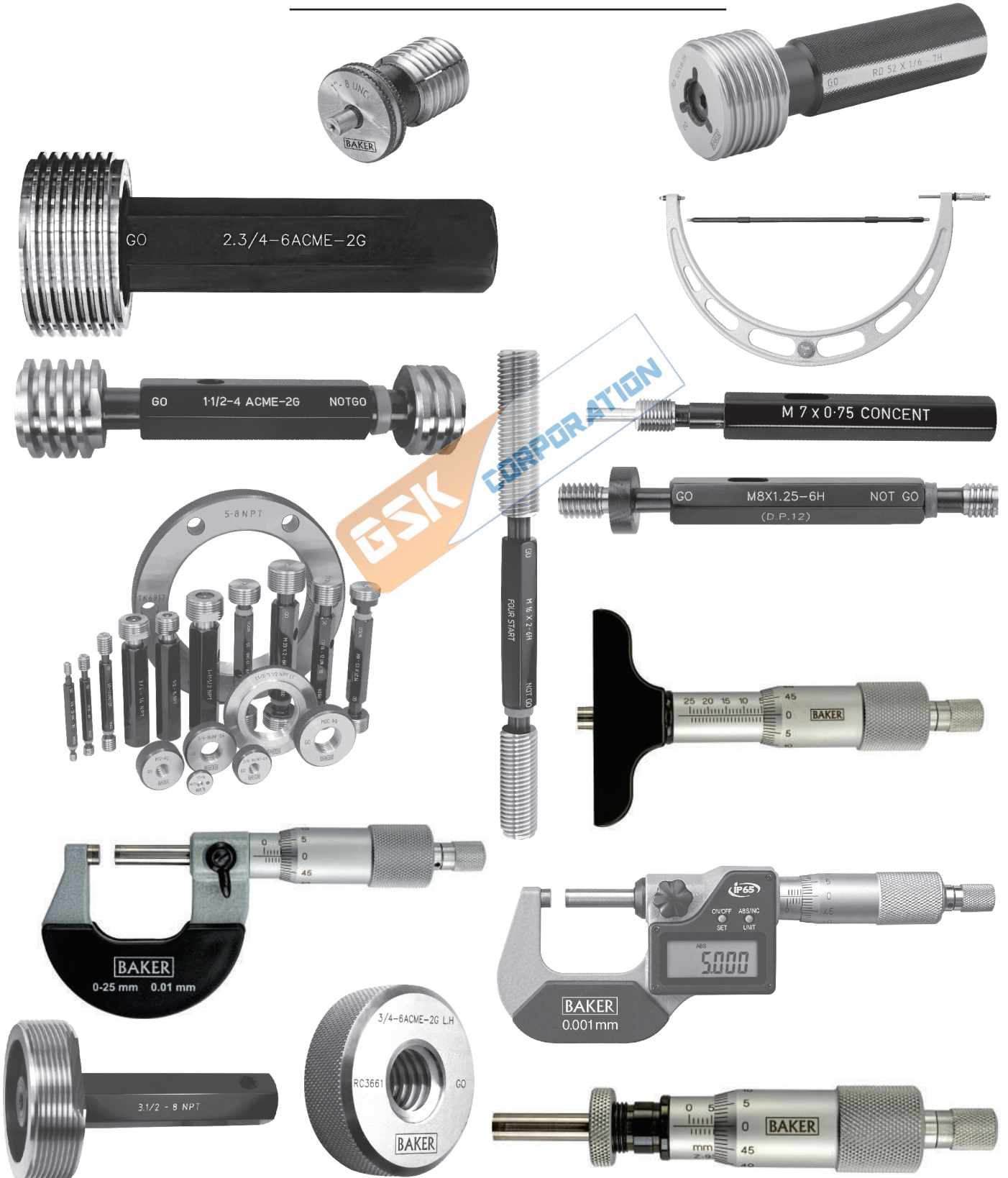

DESCRIPTION	PAGE NO.
ISO METRIC THREAD GAUGES	50 - 53
SET OF METRIC THREAD GAUGES (M3 - M12)	54
UNIFIED THREAD GAUGES	55 - 57
ISO PARALLEL PIPE THREAD GAUGES (BSP)	58
BSPT TAPER THREAD GAUGES	58
FORM (B.S. CYCLE SCREW GAUGE)	59
SCREW GAUGE (BSW/BSF)	59
B.A. SCREW GAUGE	60
THREAD DEPTH GAUGE	60
3/4 NGT, ISO 7R & NPT THREAD PLAIN TAPER THREAD GAUGES	61
NPT TAPER THREAD GAUGES	62
NPTF TAPER THREAD GAUGES	62
ANPT TAPER THREAD GAUGES	62
EXTERNAL MICROMETERS	63 - 64
MICROMETERS WITH INTERCHANGEABLE ANVILS	63 - 64
EXTERNAL MICROMETER WITH ADD ON EXTENSION ANVIL	63 - 64
MICROMETER HEADS	63 - 64
DEPTH MICROMETERS	63 - 64
SETS OF MECHANICAL MICROMETERS	65
INTERNAL MICROMETERS (Caliper Jaw Type / Tubular Micrometer)	65
SPECIAL EXTERNAL MICROMETERS	66 - 68
BLADE MICROMETERS	68
SETTING GAUGES FOR EXTERNAL MICROMETERS	68
SPARES FOR MECHANICAL	69
DIGITAL MICROMETERS SPARES	70
INTERCHANGEABLE BALL ANVIL / SPINDLE TIP	70
DIGITAL EXTERNAL MICROMETERS WITH / WITHOUT DATA OUTPUT	71
VALUE LINE DIGITAL EXTERNAL MICROMETER	71
SPECIAL DIGITAL MICROMETER	72
CALIBRATION - THREAD GAUGES & PLAIN GAUGES	73
CALIBRATION - MECHANICAL EXTERNAL MICROMETERS	74
CALIBRATION - DIGITAL EXTERNAL MICROMETERS	74
TERMS & CONDITIONS (for services)	74
CALIBRATION SERVICES	75
ISO 9001 QMS CERTIFICATE	76
NABL CERTIFICATE OF ACCREDITATION	77
NABL SCOPE OF ACCREDITATION	78 - 86

Note:

We manufacture all types of special thread gauges like ACME / STUB ACME / TRAPEZOIDAL / BUTTRESS / ROUND / Pg & Specials made to drawings.

ISO METRIC THREAD GAUGES

I. INDIAN STANDARD (IS)

BASIC DIMENSIONS : IS 4218 PART III : 1999
IS 4218 PART IV : 2001

GAUGING PRACTICE : IS 2334 : 2001

II. INTERNATIONAL ORGANIZATION FOR STANDARDIZATION (ISO)

BASIC DIMENSIONS : ISO 724 :2023
: ISO 965-1 : 2013

GAUGING PRACTICE : ISO 1502 : 1996

RIGHT HAND		THREAD PLUGS D/E GO & NOT GO	THREAD RINGS GO OR NOT GO	WCP GO OR NOT GO	RIGHT HAND	THREAD PLUGS D/E GO & NOT GO	THREAD RINGS GO OR NOT GO	WCP GO OR NOT GO			
NOMINAL DIAMETER	PITCH	CLASS 6H ₹	CLASS 6g ₹	CLASS 6g ₹	NOMINAL DIAMETER	CLASS 6H ₹	CLASS 6g ₹	CLASS 6g ₹			
1	0.25	5H 3610	6h 12320	4510	8	1.25 1.00 0.75 0.50	1850 1850 2700 4070	2000 2000 2970 5920	2300 2300 3370 5090		
1.1	0.25	5H 3610	6h 12320	4510	9	1.25 1.00 0.75 0.50	1870 1870 2700 4070	2000 2000 2970 5920	2300 2300 3370 5090		
1.2	0.25	5H 3610	6h 12320	4510		10	1.50 1.25 1.00 0.75 0.50	1890 1850 1850 2700 4070	2050 2000 2000 2970 5920	2350 2300 2300 3370 5090	
1.4	0.30	5H 2930	6h 12320	5000			11	1.50 1.00 0.75 0.50	1890 1850 2700 4070	2050 2000 2970 5920	2650 2590 3770
1.6	0.35	2930	7010	3660	12			1.75 1.50 1.25 1.00 0.75 0.50	1890 1890 1850 1850 2700 4070	2050 2050 2000 2000 2970 5920	2650 2650 2590 2590 3770 5090
1.8	0.35	2930	7010	3660				13	1.50 1.00	2950 2950	4270 4270
2	0.40 0.25	1930 2870	3250 4630	2410 3590		14	2.00 1.50 1.25 1.00 0.75		2530 2130 2130 2130 3180	3500 2270 2270 2270 4500	3540 2980 2980 2980 4430
2.2	0.45 0.25	1930 2890	3250 4630	2410 3590	15		1.50 1.00 0.75		2680 2680	2950 2950	3750 3750
2.3	0.40	2400	3250	2990			16	2.00 1.50 1.00 1.25 0.75	2530 2130 2130 3180 5300	3500 2270 2270 4500 6750	3540 2980 2980 4430 7430
2.5	0.45 0.35	1930 2890	2550 3860	2410 3590		17		1.50 1.00	2870 2870	3640 3640	4040 4040
2.6	0.45	2400	3250	2990	18			2.50 2.00 1.50 1.00	3400 2870 2670 2670	3890 3780 3400 3400	4750 4040 3740 3740
3	0.50 0.35	1850 2700	2000 2970	2300 3370			19	1.50 1.00	3680 3680	5050 5050	5160 5160
3.5	0.60 0.35	1850 2700	2000 2970	2300 3370		20		2.50 2.00 1.50 1.00	3400 2870 2670 2670	4950 4820 3400 3400	4750 4040 3740 3740
4	0.70 0.75 0.50	1850 2700 2700	2000 2970 2970	2300 3370 3370							
4.5	0.75 0.50	1850 2700	2000 2970	2300 3370							
5	0.80 0.75 0.50	1850 2700 2700	2000 2970 2970	2300 3370 3370							
5.5	0.50	2700	2970	3370							
6	1.00 0.75 0.50	1850 2700 4070	2000 2970 5920	2300 3370 5090							
7	1.00 0.75 0.50	1850 2700 4070	2000 2970 5920	2300 3370 5090							

ISO METRIC THREAD GAUGES

BAKER
...a passion for precision

RIGHT HAND		THREAD PLUGS D/E GO & NOT GO	THREAD RINGS GO OR NOT GO	WCP GO OR NOT GO	RIGHT HAND		THREAD PLUGS D/E GO & NOT GO	THREAD RINGS GO OR NOT GO
NOMINAL DIAMETER	PITCH	CLASS 6H ₹	CLASS 6g ₹	CLASS 6g ₹	NOMINAL DIAMETER	PITCH	CLASS 6H ₹	CLASS 6g ₹
21	1.5	3680	6460	5160	40	3.0	5830	7230
	1.0	3680	6460	5160		2.0	4700	6210
22	2.5	3400	4950	4750	42	1.5	4330	6090
	2.0	2870	4820	4040		1.0	6470	8950
	1.5	2670	3400	3740		4.5	8340	9440
	1.0	2670	3400	3740		4.0	8340	8660
24	3.0	3400	5180	4750	45	3.0	7030	8660
	2.0	2870	4820	4040		2.0	5390	7780
	1.5	2670	3990	3740		1.5	4960	7460
	1.0	2670	3990	3740		1.0	7400	11170
25	2.0	3490	5260	4780	48	4.5	8340	9440
	1.5	3200	4660	4410		4.0	8340	8660
	1.0	3200	4660	4410		3.0	7030	8660
26	1.5	3570	4660		50	2.0	5390	7780
	1.0	3570	7030			1.5	4960	7460
27	3.0	4720	6460		52	1.0	7400	11170
	2.0	3880	5290			3.0	7030	8660
	1.5	3570	4660			2.0	5400	7790
	1.0	3570	4660			1.5	4960	7460
28	2.0	3880	5290		55	1.0	7400	11170
	1.5	3570	4660			5.0	9750	10780
29	1.5	5340	7030		56	4.0	8340	8660
	1.0	5340	7030			3.0	7030	8660
30	3.5	6700	7230		60	2.0	5390	7780
	3.0	5830	7230			1.5	4960	7460
	2.0	4700	6210			1.0	7400	11170
	1.5	4330	5970			RIGHT HAND	THREAD PLUGS S/E GO OR NOT GO	THREAD RINGS GO OR NOT GO
	1.0	5370	7460			NOMINAL DIAMETER	PITCH	CLASS 6H ₹
32	2.0	4700	6210		58	5.0	5870	13060
	1.5	4330	5970			4.0	5870	12040
	1.0	6470	8950			3.0	4570	11510
						2.0	3510	10290
33	3.5	7000	7230		62	1.5	3250	9870
	3.0	5830	7230			4.0	5870	12040
	2.0	4700	6210			3.0	5870	12040
	1.5	4330	5970			2.0	4570	11510
	1.0	6470	8950			1.5	3510	10290
34	1.5	4330	6090		66	1.5	3250	9870
	1.0	6470	8950			4.0	5870	12040
35	1.5	4330	6090		68	3.0	4570	11510
	1.0	6470	8950			2.0	3510	10290
36	4	7000	7230		70	1.5	3250	9870
	3.0	5830	7230			4.0	5870	12040
	2.0	4700	6210			3.0	5870	12040
	1.5	4330	6090			2.0	4570	11510
	1.0	6470	8950			1.5	3510	10290
38	1.5	4330	6090		72	1.5	3250	9870
	1.0	6470	8950			4.0	5870	12040
39	4	7000	7230		74	3.0	4570	11510
	3.0	5830	7230			2.0	3510	10290
	2.0	4700	6210			1.5	3250	9870
	1.5	4330	6090			4.0	5870	12040
	1.0	6470	8950			3.0	4570	11510

ISO METRIC THREAD GAUGES

RIGHT HAND		THREAD PLUGS S/E GO OR NOT GO	THREAD RINGS GO OR NOT GO	RIGHT HAND		THREAD PLUGS S/E GO OR NOT GO	THREAD RINGS GO OR NOT GO
NOMINAL DIAMETER	PITCH	CLASS 6H ₹	CLASS 6g ₹	NOMINAL DIAMETER	PITCH	CLASS 6H ₹	CLASS 6g ₹
64	6.0	6910	14080	95	6.0	10470	22970
	4.0	5870	12040		4.0	8680	18710
	3.0	4570	11510		3.0	6980	17920
	2.0	3510	10290		2.0	5330	16040
	1.5	3250	9870		1.5	4920	15350
65	4.0	5870	12040	100	6.0	10470	22970
	3.0	4570	11510		4.0	8680	18710
	2.0	3510	10290		3.0	6980	17920
	1.5	3250	9870		2.0	5340	16040
68	6.0	7250	15890	105	6.0	13720	29800
	4.0	6130	13700		4.0	10000	25020
	3.0	4790	11510		3.0	9520	23910
	2.0	3640	10290		2.0	6780	19450
	1.5	3360	9870		1.5	6510	18680
70	6.0	7250	15890	110	6.0	13720	29800
	4.0	6130	13700		4.0	10000	25020
	3.0	4790	11510		3.0	9520	23910
	2.0	3640	10290		2.0	6780	19450
	1.5	3360	9870		1.5	6510	18680
72	6.0	7250	15890	115	6.0	13720	29800
	4.0	6130	13700		4.0	10000	25020
	3.0	4790	11510		3.0	9520	23910
	2.0	3640	10290		2.0	6780	19450
	1.5	3360	9870		1.5	6510	18680
75	4.0	6250	13700	120	6.0	13940	30490
	3.0	4790	11510		4.0	10530	27560
	2.0	3640	10290		3.0	10280	26350
	1.5	3360	9870		2.0	7100	21440
					1.5	7290	20530
76	6.0	8700	19120	125	6.0	13940	30490
	4.0	7340	15030		4.0	10530	27560
	3.0	5830	14360		3.0	10280	26350
	2.0	4420	12820		2.0	7100	21440
	1.5	4080	12290		1.5	7290	20530
78	2.0	4420	12820	130	6.0	13940	30490
	1.5	4080	12290		4.0	10530	27560
80	6.0	8700	19120	135	6.0	18230	40020
	4.0	7340	15030		4.0	11930	31590
	3.0	5830	14360		3.0	11360	30220
	2.0	4420	12820		2.0	8710	23630
	1.5	4080	12290		1.5	8330	22650
82	2.0	4420	12820	140	6.0	18230	40020
	1.5	4080	12290		4.0	11930	31590
					3.0	11360	30220
					2.0	8710	23630
					1.5	8330	22650
85	6.0	8700	19120	145	6.0	18230	40020
	4.0	7340	15030		4.0	11930	31590
	3.0	5830	14360		3.0	11360	30220
	2.0	4420	12820		2.0	8710	23630
	1.5	4080	12290		1.5	8330	22650
90	6.0	10470	22970		6.0	18230	40020
	4.0	8680	18710		4.0	11930	31590
	3.0	6980	17920		3.0	11360	30220
	2.0	5330	16040		2.0	8710	23630
	1.5	4920	15350		1.5	8330	22650

ISO METRIC THREAD GAUGES

BAKER
...a passion for precision

RIGHT HAND		THREAD PLUGS S/E GO OR NOT GO	THREAD RINGS GO OR NOT GO	RIGHT HAND		THREAD PLUGS S/E GO OR NOT GO	THREAD RINGS GO OR NOT GO
NOMINAL DIAMETER	PITCH	CLASS 6H ₹	CLASS 6g ₹	NOMINAL DIAMETER	PITCH	CLASS 6H ₹	CLASS 6g ₹
150	6.0	22500	49360	180	6.0	27710	60840
	4.0	14710	33610		4.0	20190	40590
	3.0	14710	32180		3.0	20190	40590
	2.0	11270	25880		2.0	15440	34570
	1.5	10810	24810		1.5	14780	33100
155	6.0	22500	49360	185	6.0	27710	60840
	4.0	14710	33610		4.0	20190	40590
	3.0	14710	32180		3.0	20190	40590
	2.0	12190	25880		2.0	15440	34570
	1.5	11680	24810		1.5	14780	33100
160	6.0	22500	49360	190	6.0	27710	60840
	4.0	14710	33610		4.0	20190	40590
	3.0	14710	32180		3.0	20190	40590
	2.0	12190	25880		2.0	15440	34570
	1.5	11680	24810		1.5	14780	33100
165	6.0	25590	56170	195	6.0	33900	74430
	4.0	17920	36940		4.0	23220	52000
	3.0	17490	35320		3.0	23220	52000
	2.0	13390	27630		2.0	17800	39850
	1.5	12830	26430		1.5	17030	38150
170	6.0	25590	56170	200	6.0	33900	74430
	4.0	17920	36940		4.0	23220	52000
	3.0	17490	35320		3.0	23220	52000
	2.0	13390	27630		2.0	17800	39850
	1.5	12830	26430		1.5	17030	38150
175	6.0	25590	56170	Prices for above 200 mm & specials on request			
	4.0	17920	36940				
	3.0	17490	35320				
	2.0	13390	27630				
	1.5	12830	26430				

SET OF THREAD PLUGS GAUGES IN ONE BOX CONSISTING OF M3, M4, M5, M6, M8, M10, M12 - 6H CLASS OF FIT DOUBLE END THREAD PLUG GAUGES.

PRICE : Rs. 13730/- PER BOX.



SET OF "GO" THREAD RINGS GAUGES IN ONE BOX CONSISTING OF M3, M4, M5, M6, M8, M10, M12 - 6g CLASS OF FIT "GO" THREAD RING GAUGES.

PRICE : Rs. 14800/- PER BOX.



SET OF "NOT GO" THREAD RINGS GAUGES IN ONE BOX CONSISTING OF M3, M4, M5, M6, M8, M10, M12 - 6g CLASS OF FIT "NOT GO" THREAD RING GAUGES.

PRICE : Rs. 14800/- PER BOX.

NOTES:

I] THREAD PLUGS

- 1 PRICE FOR DIAMETER 0.50 mm TO 0.90 mm ON REQUEST.
- 2 FOR SIZES 1 mm TO 1.4 mm AS PER SPECIFICATION STANDARD CLASS RECOMMENDED IS 5H/6H.
- 3 PRICE FOR THREAD PLUG OTHER THAN 6H CLASS, ADD 25% ON 6H THREAD PLUG.
- 4 PRICE FOR LEFT HAND THREAD PLUG, ADD 50% ON RIGHT HAND THREAD PLUG.
- 5 PRICE FOR NON-STANDARD DIAMETER-PITCH COMBINATIONS AND DIAMETERS ABOVE 200 mm ON REQUEST.

II] THREAD RINGS

- 1 PRICE FOR DIAMETER 0.50 mm TO 0.90 mm ON REQUEST.
- 2 PRICE FOR THREAD RING OTHER THAN 6g CLASS, DIAMETER UPTO AND INCLUDING 24 mm ADD 40% ON 6g THREAD RING.
- 3 PRICE FOR THREAD RING OTHER THAN 6g CLASS, DIAMETER ABOVE 24 mm ADD 25% ON 6g THREAD RING.
- 4 PRICE FOR LEFT HAND THREAD RING GAUGE ADD 50% ON RIGHT HAND THREAD RING GAUGE.
- 5 PRICE FOR NON-STANDARD DIAMETER-PITCH COMBINATIONS AND DIAMETERS ABOVE 200 mm ON REQUEST.

III] CERTIFICATE OF INSPECTION SUPPLIED WITH EACH GAUGE, TRACEABLE TO NATIONAL LENGTH STANDARDS.

UNIFIED THREAD GAUGES



AMERICAN STANDARD
GAUGING PRACTICE : ANSI / ASME B1.2 - 1983

RIGHT HAND		THREAD PLUGS D/E GO & NOT GO	THREAD RINGS GO OR NOT GO	WCP GO OR NOT GO	RIGHT HAND		THREAD PLUGS D/E GO & NOT GO	THREAD RINGS GO OR NOT GO	WCP GO OR NOT GO	
NOMINAL DIAMETER	THREADS PER INCH	CLASS 2B ₹	CLASS 2A ₹	CLASS 2A ₹	NOMINAL DIAMETER	THREADS PER INCH	CLASS 2B ₹	CLASS 2A ₹	CLASS 2A ₹	
No. 0	80 UNF	6570	10110	8210	3/4	10 UNC	3740	5000	5230	
No. 1	64 UNC	5570	9280	6970		16 UNF	3170	3360	4440	
	72 UNF	5570	9280	6970		12 UN	4770	6700	6690	
No. 2	56 UNC	3690	5950	4620	13/16	18 UNEF	4770	7870	6690	
	64 UNF	4620	9000	5780		20 UNEF	4770	7870	6690	
No. 3	48 UNC	3690	4770	4620		7/8	12 UN	4770	6700	6690
	56 UNF	4620	7150	5780	16 UN		4770	7870	6690	
No. 4	40 UNC	1930	2530	2410	15/16		18 UNEF	4770	7870	6690
	48 UNF	1930	2530	2410		20 UNEF	4770	7870	6690	
No. 5	40 UNC	2200	2870	2740		1	9 UNC	5050	8320	7080
No. 6	32 UNC	2200	2870	2740	8 UN		14 UNF	3170	3360	4440
	40 UNF	2200	2870	2740			12 UN	4770	7870	6690
No. 8	32 UNC	2200	2870	2740		1.1/16	16 UN	4770	7870	6690
	36 UNF	2200	2870	2740	18 UNEF		4770	7870	6690	
No. 10	24 UNC	2200	2870	2740	1.1/8		20 UNEF	4770	7870	6690
	32 UNF	2200	2870	2740		8 UN	8250	11560		
No. 12	24 UNC	2200	2870	2740		7/16	12 UN	4600	7180	
	28 UNF	2200	2870	2740	16 UN		5190	8560		
1/4	20 UNC	2200	2870	2740	1.3/16		18 UNEF	7850	11510	
	28 UNF	2200	2870	2740		20 UNEF	7850	11510		
5/16	20 UNC	2200	2870	2740		1.1/4	7 UNC	8250	11560	
	32 UNEF	3250	5750	4050	8 UN		8250	11560		
3/8	18 UNC	2200	2870	2740	1.5/16		12 UNF	4600	7180	
	24 UNF	2200	2870	2740		16 UN	5190	8560		
7/16	16 UNC	2200	2870	2740		1.1/2	18 UNEF	7850	11510	
	32 UNEF	3250	5750	4050	20 UN		7850	11510		
1/2	14 UNC	2270	3160	3190	9/16		7 UNC	8250	11560	
	20 UNF	2200	2870	2740		8 UN	8250	11560		
9/16	28 UNEF	3250	5750	4050		5/8	12 UNF	5190	7180	
	13 UNC	2270	3160	3190	16 UN		5190	8560		
5/8	20 UNF	2200	2870	2740	11/16		18 UNEF	7850	11510	
	28 UNEF	3250	5750	4050		20 UN	7850	11510		
11/16	12 UNC	2530	4880	3550			7 UNC	8250	11560	
	18 UNF	2530	3360	3550	8 UN		8250	11560		
	20 UN	3780	6700	5280	12 UNF		5190	7180		
	24 UNEF	3780	6700	5280	16 UN	5190	8560			
	11 UNC	3740	5000	5230		18 UNEF	7850	11510		
	18 UNF	3180	3360	4440		20 UN	7850	11510		
	20 UN	4770	6700	6690			8 UN	8250	11560	
	24 UNEF	4770	6700	6690	12 UN		5190	7180		
	12 UN	4770	6700	6690			16 UN	5190	8560	
	16 UN	4770	6700	6690		18 UNEF	7850	11510		
	18 UN	4770	7870	6690			20 UN	7850	11510	
	20 UN	4770	7870	6690	8 UN		8250	11560		
	24 UNEF	4770	7870	6690			12 UN	5190	7180	
						16 UN	5190	8560		

UNIFIED THREAD GAUGES

RIGHT HAND		THREAD PLUGS D/E GO & NOT GO	THREAD RINGS GO OR NOT GO	RIGHT HAND		THREAD PLUGS S/E GO OR NOT GO	THREAD RINGS GO OR NOT GO		
NOMINAL DIAMETER	THREADS PER INCH	CLASS 2B ₹	CLASS 2A ₹	NOMINAL DIAMETER	THREADS PER INCH	CLASS 2B ₹	CLASS 2A ₹		
1.3/8	6 UNC	8250	11560	2.1/2	4 UNC	8040	19060		
	8 UN	8250	11560		8 UN	6740	15890		
	12 UNF	5190	7180		12 UN	4520	11390		
	16 UN	5190	8560		16 UN	4520	11390		
	18 UNEF	7850	11510		2.5/8	8 UN	6740	15890	
20 UN	7850	11510	12 UN	4520		11390			
1.7/16	6 UN	8250	11560	16 UN		4520	11390		
	8 UN	8250	11560	2.3/4		4 UNC	8040	19060	
	12 UN	5190	7180			8 UN	6740	15890	
	16 UN	5190	8560		12 UN	4520	11390		
	18 UNEF	7850	11510		16 UN	4520	11390		
20 UN	7850	11510	1.1/2		6 UN	8250	11560		
8 UN	8250	11560		8 UN	8250	11560			
12 UN	5190	7180		12 UN	5190	7180			
16 UN	5190	8560		16 UN	5190	8560			
18 UNEF	7850	11510		18 UNEF	7850	11510			
20 UN	7850	11510	20 UN	7850	11510	2.7/8	8 UN	6740	15890
1.9/16	6 UN	9740	12580	12 UN	4520		11390		
	8 UN	9740	12580	16 UN	4520		11390		
	12 UN	7260	7860	3	4 UNC		10280	23800	
	16 UN	7260	8560		8 UN		8500	19910	
	18 UNEF	8950	11790		12 UN	5700	14220		
20 UN	8950	11790	16 UN		5700	14220			
1.5/8	8 UN	9740	12580		3.1/4	4 UNC	10280	23800	
	12 UN	7260	7860	8 UN		8500	19910		
	16 UN	7260	8560	12 UN		5700	14220		
	18 UNEF	8950	11790	16 UN		5700	14220		
	20 UN	8950	11790	3.1/2		4 UNC	13020	29800	
1.3/4	5 UNC	11770	15670		8 UN	10660	24900		
	8 UN	9740	12580		12 UN	7160	17830		
	12 UN	7260	7860		16 UN	7160	17830		
	16 UN	7260	8560		3.3/4	4 UNC	13020	29800	
	20 UN	8950	11790	8 UN		10660	24900		
1.7/8	8 UN	9740	12580	12 UN		7160	17830		
	12 UN	7260	7860	16 UN		7160	17830		
	16 UN	7260	8560	4		4 UNC	13510	30900	
	20 UN	8950	11790		8 UN	11060	25830		
	RIGHT HAND	THREAD PLUGS S/E GO OR NOT GO			THREAD RINGS GO OR NOT GO		12 UN	7430	18490
NOMINAL DIAMETER		THREADS PER INCH	CLASS 2B ₹		CLASS 2A ₹	16 UN	7430	18490	
2		4.5 UN	6430		16250	4.1/4	4 UNC	16280	35750
		8 UN	5310	13050	8 UN		11400	28710	
		12 UN	3770	8150	12 UN		8140	23360	
	16 UN	3770	8880	16 UN	8140		23360		
	20 UN	4660	12230	4.1/2	4 UNC		16280	35750	
2.1/4	4.5 UN	8040	19060		8 UN	11400	28710		
	8 UN	6740	15890		12 UN	8140	23360		
	12 UN	4520	11390		16 UN	8140	23360		
	16 UN	4520	11390		4.3/4	4 UNC	16280	36590	
	2.3/8	8 UN	6740	15890		8 UN	11400	31650	
12 UN		4520	11390	12 UN		8140	25700		
16 UN		4520	11390	16 UN		8140	25700		
5		4 UNC	16280	36590		8 UN	11400	31650	
		8 UN	11400	25700	12 UN	8140	25700		
	12 UN	8140	25700	16 UN	8140	25700			
	16 UN	8140	25700						

UNIFIED THREAD GAUGES



RIGHT HAND		THREAD PLUGS S/E GO OR NOT GO	THREAD RINGS GO OR NOT GO	RIGHT HAND		THREAD PLUGS S/E GO OR NOT GO	THREAD RINGS GO OR NOT GO
NOMINAL DIAMETER	THREADS PER INCH	CLASS 2B ₹	CLASS 2A ₹	NOMINAL DIAMETER	THREADS PER INCH	CLASS 2B ₹	CLASS 2A ₹
5.1/4	4 UNC	21870	48010	5.3/4	4 UNC	27140	59250
	8 UN	13630	36280		8 UN	17640	38590
	12 UN	11400	28350		12 UN	13520	31060
	16 UN	10000	27170		16 UN	12950	29760
5.1/2	4 UNC	21870	48010	6	4 UNC	27140	59250
	8 UN	13630	36280		8 UN	17640	38590
	12 UN	11400	28380		12 UN	13520	31060
	16 UN	10000	27170		16 UN	12950	29760

Prices for above 6" & specials on request

NOTES:

I] THREAD PLUGS

- 1 PRICE FOR THREAD PLUG OTHER THAN 2B CLASS, ADD 25% ON 2B THREAD PLUG.
- 2 PRICE FOR LEFT HAND THREAD PLUG, ADD 50% ON RIGHT HAND.
- 3 PRICE FOR NON-STANDARD DIAMETER-TPI COMBINATIONS AND DIAMETERS ABOVE 6" ON REQUEST.

II] THREAD RINGS

- 1 PRICE FOR THREAD RING OTHER THAN 2A CLASS, DIAMETER UPTO AND INCLUDING 1" ADD 40% ON 2A THREAD RING.
- 2 PRICE FOR THREAD RING OTHER THAN 2A CLASS, DIAMETER ABOVE 1" ADD 25% ON 2A THREAD RING.
- 3 PRICE FOR LEFT HAND THREAD RING, ADD 50% ON RIGHT HAND THREAD RING GAUGES.
- 4 PRICE FOR NON-STANDARD DIAMETER-TPI COMBINATIONS AND DIAMETERS ABOVE 6" ON REQUEST.

III] CERTIFICATE OF INSPECTION IS SUPPLIED WITH EACH GAUGE, TRACEABLE TO NATIONAL LENGTH STANDARDS.

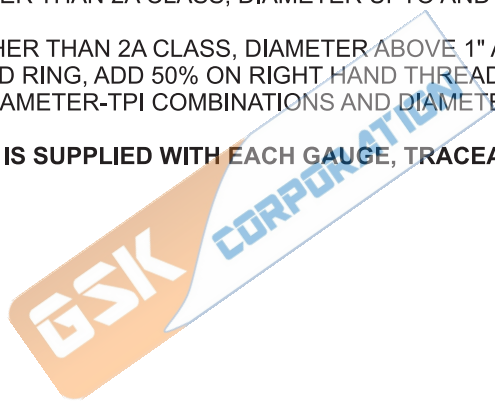

ISO PARALLEL PIPE THREAD GAUGES (BSP)

I. INDIAN STANDARD (IS)

 BASIC DIMENSIONS : IS 2643 : 2005
 GAUGING PRACTICE : IS 10216 :1988

II. INTERNATIONAL ORGANIZATION FOR STANDARDIZATION (ISO)

 BASIC DIMENSIONS : ISO 228-1:2000
 GAUGING PRACTICE : ISO 228-2:1987

RIGHT HAND		THREAD PLUGS D/E GO & NOT GO	THREAD RINGS GO OR NOT GO	WCP GO OR NOT GO	THREAD RINGS NOT GO
NOMINAL DIAMETER	THREADS PER INCH	CLASS GENERAL ₹	CLASS B ₹	CLASS B ₹	CLASS A ₹
G 1/16	28	2410	3910	3000	5860
G 1/8	28	2410	3910	3000	5860
G 1/4	19	2410	3910	3370	5860
G 3/8	19	2410	3910	3370	5860
G 1/2	14	3020	5750	4240	8620
G 5/8	14	3020	5750	4240	7180
G 3/4	14	3020	5750	4240	7180
G 7/8	14	3080	5840	4320	7310
G 1	11	5290	8350		10430
G 1.1/8	11	5290	8350		10430
G 1.1/4	11	5290	8350		10430
G 1.3/8	11	5290	8350		10430
G 1.1/2	11	5290	8350		10430

RIGHT HAND		THREAD PLUGS S/E GO OR NOT GO	THREAD RINGS GO OR NOT GO		THREAD RINGS NOT GO
NOMINAL DIAMETER	THREADS PER INCH	CLASS GENERAL ₹	CLASS B ₹		CLASS A ₹
G 1.3/4	11	3110	9920		12410
G 2	11	3220	10860		13590
G 2.1/4	11	3570	10860		13590
G 2.1/2	11	3570	10860		13590
G 2.3/4	11	4460	13600		17000
G 3	11	4460	13600		17000
G 3.1/2	11	5530	17030		21300
G 4 - 11	11	5530	17030		21300
G 5 - 11	11	8140	21670		27090
G 6 - 11	11	12200	27070		33830

NOTES:
I] THREAD PLUGS

1. PRICE FOR LEFT HAND THREAD PLUG, ADD 50% ON RIGHT HAND THREAD PLUG

II] THREAD RINGS

- PRICE FOR NOT GO THREAD RING OF CLASS-A, DIAMETER UPTO AND INCLUDING G1/2" ADD 50% ON CLASS B THREAD RING.
- PRICE FOR NOT GO THREAD RING OF CLASS-A, ADD 25% ON CLASS B ABOVE G1/2" THREAD RING.
- PRICE FOR LEFT HAND THREAD RING, ADD 50% ON RIGHT HAND THREAD RING

III] CERTIFICATE OF INSPECTION IS SUPPLIED WITH EACH GAUGE, TRACEABLE TO NATIONAL LENGTH STANDARDS.

BSPT TAPER THREAD GAUGES

BASIC DIMENSIONS & GAUGING PRACTICE
BS 21:1985

NOMINAL DIAMETER	THREADS PER INCH	PLUGS SYSTEM - B ₹	RINGS SYSTEM - B ₹
1/16	28	7560	13340
1/8	28	7560	12470
1/4	19	6090	11650
3/8	19	6090	9980
1/2	14	6090	7910
3/4	14	6090	7910
1	11	8650	11480
1.1/4	11	8650	11480
1.1/2	11	8650	11480
2	11	13380	14870
2.1/2	11	13710	14870
3	11	13710	14870
4	11	20630	22310
5	11	23600	25630
6	11	23600	25630

NOTE: DETAILED CERTIFICATE OF INSPECTION IS SUPPLIED WITH EACH GAUGE, TRACEABLE TO NATIONAL LENGTH STANDARDS.

BRITISH STANDARD WITHWORTH THREAD GAUGES



FORM (B.S. CYCLE SCREW GAUGE)

Basic Dimensions : BS 84-2007
Gauging Practice : BS 919 PART - II. 2007
CLASS OF FIT : MEDIUM

NOMINAL DIAMETER	THREADS PER INCH	THREAD PLUGS D/E GO & NOT GO CLASS MEDIUM ₹	THREAD RINGS GO OR NOT GO PRICE IN RS EACH CLASS MEDIUM ₹
9 SWG	40	5440	9270
10 SWG	40	5440	9270
11 SWG	44	5440	9270
12 SWG	56	5770	10040
14 SWG	56	5770	10040
7/32"	26	3660	5330
1/4"	26	3660	5330
9/32"	26	3660	5330
5/16"	26	3660	5330
3/8"	26	3660	5330
7/16"	26	3660	5330
1/2"	26	3660	5330
9/16"	26	4150	7230
5/8"	26	4150	7230
11/16"	26	4150	7230
3/4"	26	4340	7510
1"	26	4340	7930
1 1/4"	26	5350	8280
1 1/2"	26	5350	8280
1 3/4"	26	6930	10600
1"	24	4150	7510
1.37	24 RH	4730	8280
1.371	24 LH	6160	10740
1.555 (38.50 MM)	24 RH	6540	9020
1.555 (38.50 MM)	24 LH	8490	11790

SCREW GAUGE (BSW/BSF)

Basic Dimensions : BS 84-2007
Gauging Practice : BS 919 PART - II. 2007
CLASS OF FIT : MEDIUM

NOMINAL DIAMETER	THREADS PER INCH	THREAD PLUGS D/E GO & NOT GO CLASS MEDIUM ₹	THREAD RINGS GO OR NOT GO PRICE IN RS EACH CLASS MEDIUM ₹
1/8"	40 BSW	6030	7790
3/16"	24 BSW	3760	7790
	32 BSF	3760	5230
1/4"	20 BSW	3760	5230
	26 BSF	3760	5230
5/16"	18 BSW	3760	5230
	22 BSF	3760	5230
3/8"	16 BSW	3760	5230
	20 BSF	3760	5230
7/16"	14 BSW	3760	5230
	18 BSF	3760	5230
1/2"	12 BSW	3760	5230
	16 BSF	3760	5230
9/16"	12 BSW	3760	5230
	16 BSF	3760	5230
5/8"	11 BSW	3760	4070
	14 BSF	3760	4070
3/4"	10 BSW	6900	7470
	12 BSF	4730	5120
7/8"	9 BSW	6900	7470
	11 BSF	5700	6180
1"	8 BSW	7190	7790
	10 BSF	7190	7790
1.1/8"	7 BSW	14470	14970
	9 BSF	14470	14970
1.1/4"	7 BSW	14470	14970
	9 BSF	14470	14970
1.1/2"	6 BSW	14470	14970
	8 BSF	14470	14970

B.A. SCREW GAUGE

Basic Dimensions : BS 93-2008
 Gauging Practices : BS 919 PART - II. 2007
 CLASS OF FIT : NORMAL

NOMINAL DIAMETER	THREADS PER INCH	THREAD PLUGS D/E GO & NOT GO CLASS MEDIUM ₹	THREAD RINGS GO OR NOT GO PRICE IN RS EACH CLASS MEDIUM ₹
NO 0 B.A.	-	6200	7650
NO 1 B.A.	-	6200	7650
NO 2 B.A.	-	6200	7650
NO 3 B.A.	-	6200	7650
NO 4 B.A.	-	6200	7650
NO 5 B.A.	-	6200	7650
NO 6 B.A.	-	7390	11400
NO 7 B.A.	-	7390	11850
NO 8 B.A.	-	8970	13650
NO 9 B.A.	-	12150	19450
NO 10 B.A.	-	12150	19450
NO 11 B.A.	-	12150	19450
NO 12 B.A.	-	12150	19450

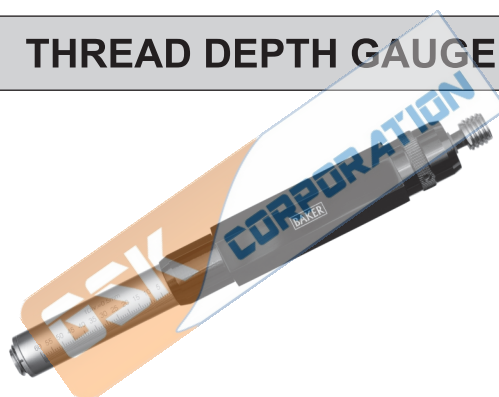
THREAD DEPTH GAUGE

TYPE	THREAD DEPTH GAUGE SIZE	MEASURING DEPTH	PRICE ₹
BDG 03	M4 X 0.7-6H THREAD DEPTH GAUGE	20 mm	16040
BDG 03	M5 X 0.8-6H THREAD DEPTH GAUGE	20 mm	16040
BDG 03	M6 X 1-6H THREAD DEPTH GAUGE	20 mm	16040
BDG 03	NO. 8 - 32 UNC - 2B THREAD DEPTH GAUGE	20 mm	16040
BDG 03	NO. 10 - 24 UNC - 2B THREAD DEPTH GAUGE	20 mm	16040
BDG 03	NO. 12 - 24 UNC - 2B THREAD DEPTH GAUGE	20 mm	16040
BDG 03	1/4 - 20 UNC - 2B THREAD DEPTH GAUGE	20 mm	16040
BDG 04	M8 X 1.25-6H THREAD DEPTH GAUGE	35 mm	16870
BDG 04	M10 X 1.5-6H THREAD DEPTH GAUGE	35 mm	16870
BDG 04	5/16 - 18 UNC - 2B THREAD DEPTH GAUGE	35 mm	16870
BDG 04	3/8 - 16 UNC - 2B THREAD DEPTH GAUGE	35 mm	16870
BDG 04	7/16 - 14 UNC - 2B THREAD DEPTH GAUGE	35 mm	16870
BDG 05	M12 X 1.75-6H THREAD DEPTH GAUGE	45 mm	17700
BDG 05	M14 X 2.0-6H THREAD DEPTH GAUGE	45 mm	17700
BDG 05	M16 X 2.0-6H THREAD DEPTH GAUGE	45 mm	17700
BDG 05	1/2 - 13 UNC - 2B THREAD DEPTH GAUGE	45 mm	17700
BDG 05	9/16 - 12 UNC - 2B THREAD DEPTH GAUGE	45 mm	17700
BDG 05	5/8 - 11 UNC - 2B THREAD DEPTH GAUGE	45 mm	17700
	SETTING MASTER FOR BDG 03		3560
	SETTING MASTER FOR BDG 04		4160
	SETTING MASTER FOR BDG 05		4510

NGT Taper Thread - 3/4-14 NGT Taper (Eight Types) IS 15894

SIZE	PRICE ₹
TAPER THREAD PLUG GAUGE A (L1) WITH BASIC/MIN/MAX. STEPS	5830
FULL FORM TAPER THREAD PLUG GAUGE B (L9) WITHOUT STEPS	6370
PLAIN TAPER PLUG GAUGE C WITHOUT STEPS	2120
TAPER THREAD RING GAUGE D (L1) WITH ONE STEP.	8730
FULL FORM TAPER THREAD RING GAUGE E (L8)	10430
PLAIN TAPER RING GAUGE F WITHOUT STEP	9770
MASTER TAPER THREAD RING GAUGE (GAUGE M-INT) WITHOUT STEP (NEW)	13310
MASTER TAPER PLUG GAUGE (GAUGE M-EXT) WITHOUT STEP.	8230

ISO 7R TAPER PIPE THREADS

Basic Dimensions ISO 7-1:1994 or IS 554-1999
Gauging Practice ISO 7-2:2000 or IS 8999-2003

NOMINAL DIAMETER	TAPER FULL FORM THREAD PLUG	PARALLEL FULL FORM THREAD RING	PLAIN TAPER RING	TAPER MODIFIED FORM CHECK PLUG FOR RING	PARALLEL THREADS CHECK RING GAUGE
	GAUGE NO. 1 ₹	GAUGE NO. 3 ₹	GAUGE NO. 4 ₹	GAUGE NO. 5 ₹	GAUGE NO. 6 ₹
1/16 - 28	9460	20830	12510	14180	31250
1/8 - 28	9460	19490	11700	14180	29250
1/4 - 19	7620	18150	10900	11430	27240
3/8 - 19	7620	15590	9360	11430	23400
1/2 - 14	7620	12350	7410	11430	18530
3/4 - 14	7620	12350	7410	11430	18530
1 - 11	10810	17940	10770	16210	26900
1.1/4 - 11	10810	17940	10770	16210	26900
1.1/2 - 11	10810	17940	10770	16210	26900
2 - 11	16730	23230	13940	25100	34840
2.1/2 - 11	17140	23230	13940	25700	34840
3 - 11	17140	23230	13940	25700	34840
4 - 11	25790	34870	20920	38680	52300
5 - 11	29500	40040	24020	44240	60070
6 - 11	29500	40040	24020	44240	60070

NPT THREAD & PLAIN GAUGES

AMERICAN STANDARD - BASIC DIMENSIONS & GAUGING PRACTICE: ASME B1.20.1-2013 OR H-28 PART II-1957.

THREAD PLUG GAUGES

SIZE	UNIT RATE ₹
1/8 -27 NPT L1 TAPER 3 STEP	6760
1/8 -27 NPT L3 TAPER 3 STEP	7880
1/8 -27 NPT L1 PLAIN 2 STEP	7320
1/4 -18 NPT L1 TAPER 3 STEP	5650
1/4 -18 NPT L3 TAPER 3 STEP	6600
1/4 -18 NPT L1 PLAIN 2 STEP	6120
3/8 -18 NPT L1 TAPER 3 STEP	5650
3/8 -18 NPT L3 TAPER 3 STEP	6600
3/8 -18 NPT L1 PLAIN 2 STEP	6120
1/2 -14 NPT L1 TAPER 3 STEP	5650
1/2 -14 NPT L3 TAPER 3 STEP	6600
1/2 -14 NPT L1 PLAIN 2 STEP	6120
3/4 -14 NPT L1 TAPER 3 STEP	5650
3/4 -14 NPT L3 TAPER 3 STEP	6600
3/4 -14 NPT L1 PLAIN 2 STEP	6120
1 - 11.1/2 NPT L1 TAPER 3 STEP	7650
1 - 11.1/2 NPT L3 TAPER 3 STEP	8910
1 - 11.1/2 NPT L1 PLAIN 2 STEP	8270
1.1/4 - 11.1/2 NPT L1 TAPER 3 STEP	7650
1.1/4 - 11.1/2 NPT L3 TAPER 3 STEP	8910
1.1/4 - 11.1/2 NPT L1 PLAIN 2 STEP	8270
1.1/2 - 11.1/2 NPT L1 TAPER 3 STEP	7650
1.1/2 - 11.1/2 NPT L3 TAPER 3 STEP	8910
1.1/2 - 11.1/2 NPT L1 PLAIN 2 STEP	8270
2 - 11.1/2 NPT L1 TAPER 3 STEP	11560
2 - 11.1/2 NPT L3 TAPER 3 STEP	13480
2 - 11.1/2 NPT L1 PLAIN 2 STEP	12530

THREAD RING GAUGES

SIZE	UNIT RATE ₹
1/8 -27 NPT L1 TAPER 3 STEP	11060
1/8 -27 NPT L2 TAPER 3 STEP	12910
1/8 -27 NPT L1 PLAIN 2 STEP	11980
1/4 -18 NPT L1 TAPER 3 STEP	10090
1/4 -18 NPT L2 TAPER 3 STEP	11770
1/4 -18 NPT L1 PLAIN 2 STEP	11300
3/8 -18 NPT L1 TAPER 3 STEP	10090
3/8 -18 NPT L2 TAPER 3 STEP	11770
3/8 -18 NPT L1 PLAIN 2 STEP	11300
1/2 -14 NPT L1 TAPER 3 STEP	8770
1/2 -14 NPT L2 TAPER 3 STEP	10230
1/2 -14 NPT L1 PLAIN 2 STEP	9510
3/4 -14 NPT L1 TAPER 3 STEP	8770
3/4 -14 NPT L2 TAPER 3 STEP	10230
3/4 -14 NPT L1 PLAIN 2 STEP	9500
1 - 11.1/2 NPT L1 TAPER 3 STEP	13490
1 - 11.1/2 NPT L2 TAPER 3 STEP	15730
1 - 11.1/2 NPT L1 PLAIN 2 STEP	14620
1.1/4 - 11.1/2 NPT L1 TAPER 3 STEP	13490
1.1/4 - 11.1/2 NPT L2 TAPER 3 STEP	15730
1.1/4 - 11.1/2 NPT L1 PLAIN 2 STEP	14620
1.1/2 - 11.1/2 NPT L1 TAPER 3 STEP	13490
1.1/2 - 11.1/2 NPT L2 TAPER 3 STEP	15730
1.1/2 - 11.1/2 NPT L1 PLAIN 2 STEP	14620
2 - 11.1/2 NPT L1 TAPER 3 STEP	17310
2 - 11.1/2 NPT L2 TAPER 3 STEP	20190
2 - 11.1/2 NPT L1 PLAIN 2 STEP	18760

NPT TAPER THREAD GAUGES

AMERICAN STANDARD

BASIC DIMENSIONS & GAUGING PRACTICE: ASME B1.20.1-2013 OR H-28 PART II-1957.

RIGHT HAND		NPT BASIC STEP		NPT MIN & MAX STEPS	
NOMINAL DIAMETER	THREADS PER INCH	PLUGS ₹	RINGS ₹	PLUGS ₹	RINGS ₹
1/16	27	4150	6160	4510	7380
1 / 8	27	4150	6160	4510	7380
1 / 4	18	3430	5580	3770	6730
3 / 8	18	3430	5580	3770	6730
1 / 2	14	3430	4880	3770	5850
3 / 4	14	3430	4880	3770	5850
1	11.1/2	4600	7530	5100	9000
1.1/4	11.1/2	4600	7530	5100	9000
1.1/2	11.1/2	4600	7530	5100	9000
2	11.1/2	6970	9650	7650	11590
2.1/2	8	8620	10550	9500	12630
3	8	8620	10550	9500	12630
3.1/2	8	8620	10550	9500	12630
4	8	12990	15870	14280	19060
5	8	14260	17450	15740	20930
6	8	14260	17450	15740	20930

NOTE : DETAILED CERTIFICATE OF INSPECTION IS SUPPLIED WITH EACH GAUGE, TRACEABLE TO NATIONAL LENGTH STANDARDS.

NPTF TAPER THREAD GAUGES

GAUGING PRACTICE :

ASME B 1.20.5 - 1991

RIGHT HAND		TAPER THREAD PLUG					TAPER THREAD RING				
Nominal Diameter	Threads Per Inch	L1 Basic ₹	L3 Basic ₹	L1 Step Limit ₹	L3 Step Limit ₹	6 Step Plain Plug ₹	L1 Basic ₹	L2 Basic ₹	L1 Step Limit ₹	L2 Step Limit ₹	6 Step Plain Ring ₹
1/16"	27	4520	4950	4980	5420	5950	6780	7390	8130	8840	9730
1/8"	27	4520	4950	4980	5420	5950	6780	7390	8130	8840	9730
1/4"	18	3780	4110	4170	4510	4960	6140	6710	7420	8100	8900
3/8"	18	3780	4110	4170	4510	4960	6140	6710	7420	8100	8900
1/2"	14	3780	4110	4170	4510	4960	5350	6710	6440	7010	7700
3/4"	14	3780	4110	4170	4510	4960	5350	6710	6440	7010	7700
1"	11.1/2	5080	5500	5570	6120	6730	8270	9010	9890	10790	11870
1.1/4"	11.1/2	5080	5500	5570	6120	6730	8270	9010	9890	10790	11870
1.1/2"	11.1/2	5080	5500	5570	6120	6730	8270	9010	9890	10790	11870
2"	11.1/2	7650	8350	8420	9180	10110	10630	11610	12750	13890	15280
2.1/2"	8	9500	10400	10440	11400	12530	11600	12640	13890	15160	16670
3"	8	9500	10400	10440	11400	12530	11600	12640	13890	15160	16670

NOTE: DETAILED CERTIFICATE OF INSPECTION IS SUPPLIED WITH EACH GAUGE, TRACEABLE TO NATIONAL LENGTH STANDARDS.

ANPT TAPER THREAD GAUGES

BASIC DIMENSIONS & GAUGING PRACTICE :

SAE AS71051B:2008

RIGHT HAND		TAPER THREAD PLUG					TAPER THREAD RING				
Nominal Diameter	Threads Per Inch	L1 Basic Step ₹	L3 Basic Step ₹	L1 Step Min/Max ₹	L3 Step Min/Max ₹	6 Step Plain Plug ₹	L1 Basic Step ₹	L2 Basic Step ₹	L1 Step Min/Max ₹	L2 Step Min/Max ₹	6 Step Plain Ring ₹
1/16	27	6970	7960	7580	8670	9550	10360	11840	12400	14170	15580
1/8	27	6970	7960	7580	8670	9550	10360	11840	12400	14170	15580
1/4	18	5780	6600	6340	7250	7970	9400	10750	11310	12930	14230
3/8	18	5780	6600	6340	7250	7970	9400	10750	11310	12930	14230
1/2	14	5780	6600	6340	7250	7970	8220	9380	9840	11240	12370
3/4	14	5780	6600	6340	7250	7970	8220	9380	9840	11240	12370
1	11.1/2	7730	8830	8560	9780	10770	12650	14460	15130	17290	19020
1.1/4	11.1/2	7730	8830	8560	9780	10770	12650	14460	15130	17290	19020
1.1/2	11.1/2	7730	8830	8560	9780	10770	12650	14460	15130	17290	19020
2	11.1/2	11710	13380	12860	14690	16160	16250	18570	19500	22280	24490
2.1/2	8	14490	16580	15970	18260	20080	17740	20280	21230	24280	26710
3	8	14490	16580	15970	18260	20080	17740	20280	21230	24280	26710

NOTE: DETAILED CERTIFICATE OF INSPECTION IS SUPPLIED WITH EACH GAUGE, TRACEABLE TO NATIONAL LENGTH STANDARDS.

EXTERNAL MICROMETERS

METRIC EXTERNAL MICROMETERS

DIN : 863 / IS 2967

TYPE	RANGE	READING	₹
MMC25	0 - 25 mm	0.01 mm	2020
MMC50	25 - 50 mm	0.01 mm	2430
MMC75	50 - 75 mm	0.01 mm	2760
MMC100	75 - 100 mm	0.01 mm	3000
MMC125	100 - 125 mm	0.01 mm	3680
MMC150	125 - 150 mm	0.01 mm	4120
MMC175	150 - 175 mm	0.01 mm	4800
MMC200	175 - 200 mm	0.01 mm	5720

TYPE	RANGE	READING	₹
MMC25-1	0 - 25 mm	0.001 mm	2330
MMC50-1	25 - 50 mm	0.001 mm	3040
MMC75-1	50 - 75 mm	0.001 mm	3360
MMC100-1	75 - 100 mm	0.001 mm	3830
MMC125-1	100 - 125 mm	0.001 mm	4820
MMC150-1	125 - 150 mm	0.001 mm	5120

METRIC EXTERNAL MICROMETERS WITH INTERCHANGEABLE ANVILS

TYPE	RANGE	READING	₹
MMI0-100	0 - 100 mm	0.01 mm	11500
MMI0-150	0 - 150 mm	0.01 mm	14800
MMI100-200	100 - 200 mm	0.01 mm	15200
MMI150-300	150 - 300 mm	0.01 mm	20800
MMI200-300	200 - 300 mm	0.01 mm	17720
MMI300-400	300 - 400 mm	0.01 mm	23360
MMI400-500	400 - 500 mm	0.01 mm	24290
MMI0-100-1	0 - 100 mm	0.001 mm	14270
MMI0-150-1	0 - 150 mm	0.001 mm	17590
MMI150-300-1	150-300 mm	0.001 mm	24420

METRIC EXTERNAL MICROMETERS WITH ADD ON EXTENSION ANVIL

TYPE	RANGE	READING	₹
MME500-600	500 - 600 mm	0.01 mm	32460
MME600-700	600 - 700 mm	0.01 mm	38430
MME700-800	700 - 800 mm	0.01 mm	42620
MME800-900	800 - 900 mm	0.01 mm	47840
MME900-1000	900 - 1000 mm	0.01 mm	56440

METRIC MICROMETERS HEAD

TYPE	RANGE	READING	₹
MM25-HP	0 - 25 mm	0.01 mm	1560
MM25-HT	0 - 25 mm	0.01 mm	1610
MM25-1HP	0 - 25 mm	0.001 mm	1720
MM25-1HT	0 - 25 mm	0.001 mm	1770

METRIC DEPTH MICROMETER

TYPE	RANGE	READING	₹
MMC25-DM60	0 - 25 mm	0.01 mm	5110
MMC25-1DM60	0 - 25 mm	0.001 mm	5340
MMC25-DM100	0 - 25 mm	0.01 mm	5625
MMC25-1DM100	0 - 25 mm	0.001 mm	5875
MMC100-DM60	0 - 100 mm	0.01 mm	6255
MMC100-DM100	0 - 100 mm	0.01 mm	6800
MMC150-DM60	0 - 150 mm	0.01 mm	7815
MMC150-DM100	0 - 150 mm	0.01 mm	8600

NOTE: CERTIFICATE OF INSPECTION IS SUPPLIED WITH EACH MICROMETER, TRACEABLE TO NATIONAL LENGTH STANDARDS.

INCH EXTERNAL MICROMETERS
ASME B89.1.13

TYPE	RANGE	READING	₹
INC1	0 - 1 inch	0.001 inch	2020
INC2	1 - 2 inch	0.001 inch	2430
INC3	2 - 3 inch	0.001 inch	2760
INC4	3 - 4 inch	0.001 inch	3000
INC5	4 - 5 inch	0.001 inch	3680
INC6	5 - 6 inch	0.001 inch	4120
INC7	6 - 7 inch	0.001 inch	4800
INC8	7 - 8 inch	0.001 inch	5720

TYPE	RANGE	READING	₹
INC1-1	0 - 1 inch	0.0001 inch	2330
INC2-1	1 - 2 inch	0.0001 inch	3040
INC3-1	2 - 3 inch	0.0001 inch	3360
INC4-1	3 - 4 inch	0.0001 inch	3830
INC5-1	4 - 5 inch	0.0001 inch	4820
INC6-1	5 - 6 inch	0.0001 inch	5120

INCH EXTERNAL MICROMETERS WITH INTERCHANGEABLE ANVILS

TYPE	RANGE	READING	₹
INI0-4	0-4 inch	0.001 inch	11500
INI0-6	0-6 inch	0.001 inch	14800
INI6-12	6-12 inch	0.001 inch	20800
INI8-12	8-12 inch	0.001 inch	17720
INI12-16	12-16 inch	0.001 inch	23360
INI16-20	16-20 inch	0.001 inch	24290
INI0-4-1	0 -4 inch	0.0001 inch	14270
INI0-6-1	0 -6 inch	0.0001 inch	17590
INI6-12-1	6-12 inch	0.0001 inch	24420

INCH EXTERNAL MICROMETERS WITH ADD ON EXTENSION ANVIL

TYPE	RANGE	READING	₹
INE20-24	20-24 inch	0.001 inch	32460
INE24-28	24-28 inch	0.001 inch	38430
INE28-32	28-32 inch	0.001 inch	42620
INE32-36	32-36 inch	0.001 inch	47840
INE36-40	36-40 inch	0.001 inch	56440

INCH MICROMETERS HEAD

TYPE	RANGE	READING	₹
IN1-HP	0 - 1 inch	0.001 inch	1560
IN1-HT	0 - 1 inch	0.001 inch	1610
IN1-1HP	0 - 1 inch	0.0001 inch	1720
IN1-1HT	0 - 1 inch	0.0001 inch	1770

INCH DEPTH MICROMETERS

TYPE	RANGE	READING	₹
INC1-DM60	0-1 inch	0.001 inch	5110
INC1-1DM60	0-1 inch	0.0001 inch	5340
INC1-DM100	0-1 inch	0.001 inch	5625
INC1-1DM100	0-1 inch	0.0001 inch	5875
INC4-DM60	0-4 inch	0.001 inch	6255
INC4-DM100	0-4 inch	0.001 inch	6880
INC6-DM60	0-6 inch	0.001 inch	7815
INC6-DM100	0-6 inch	0.001 inch	8600

NOTE: CERTIFICATE OF INSPECTION IS SUPPLIED WITH EACH MICROMETER, TRACEABLE TO NATIONAL LENGTH STANDARDS.

SPECIAL EXTERNAL MICROMETERS

1) TUBE TYPE : [TYPE - T1] SPHERICAL HARDENED STEEL ANVIL & FLAT CARBIDE SPINDLE FACE. [TYPE - T2] BOTH ENDS SPHERICAL HARDENED STEEL FACES.

TYPE	RANGE	READING	₹
MMC25 - T1	0 - 25 mm	0.01 mm	2980
MMC50 - T1	25 - 50 mm	0.01 mm	3860
MMC75 - T1	50 - 75 mm	0.01 mm	4360
MMC100 - T1	75 - 100 mm	0.01 mm	4800
MMC25 - T2	0 - 25 mm	0.01 mm	3130
MMC50 - T2	25 - 50 mm	0.01 mm	4070
MMC75 - T2	50 - 75 mm	0.01 mm	4460
MMC100 - T2	75 - 100 mm	0.01 mm	5070
TYPE	RANGE	READING	₹
INC1 - T1	0 - 1 inch	0.001 inch	2980
INC2 - T1	1 - 2 inch	0.001 inch	3860
INC3 - T1	2 - 3 inch	0.001 inch	4360
INC4 - T1	3 - 4 inch	0.001 inch	4800
INC1 - T2	0 - 1 inch	0.001 inch	3130
INC2 - T2	1 - 2 inch	0.001 inch	4070
INC3 - T2	2 - 3 inch	0.001 inch	4460
INC4 - T2	3 - 4 inch	0.001 inch	5070

2) DISC TYPE: ROTATING - HARDENED STEEL MEASURING FACES.

TYPE	RANGE	READING	₹
MMC25-D	0-25 mm	0.01 mm	6150
MMC50-D	25-50 mm	0.01 mm	6720
MMC75-D	50-75 mm	0.01 mm	7200
MMC100-D	75-100 mm	0.01 mm	8400
MMC125-D	100-125 mm	0.01 mm	9360
MMC150-D	125-150 mm	0.01 mm	9950
MMC175-D	150-175 mm	0.01 mm	14350
TYPE	RANGE	READING	₹
INC1-D	0-1"	0.001"	6150
INC2-D	1-2"	0.001"	6720
INC3-D	2-3"	0.001"	7200
INC4-D	3-4"	0.001"	8400
INC5-D	4-5"	0.001"	9360
INC6-D	5-6"	0.001"	9950
INC7-D	6-7"	0.001"	14350

3) DISC TYPE: NON - ROTATING - HARDENED STEEL MEASURING FACES.

TYPE	RANGE	READING	₹
MMC25 - ND	0 - 25 mm	0.01 mm	9670
MMC50 - ND	25 - 50 mm	0.01 mm	11620
MMC75 - ND	50 - 75 mm	0.01 mm	12340
MMC100 - ND	75 - 100 mm	0.01 mm	12830

TYPE	RANGE	READING	₹
INC1 - ND	0 - 1 inch	0.001 inch	9670
INC2 - ND	1 - 2 inch	0.001 inch	11620
INC3 - ND	2 - 3 inch	0.001 inch	12340
INC4 - ND	3 - 4 inch	0.001 inch	12830

SPECIAL EXTERNAL MICROMETERS

4) POINT TYPE : 15° HARDENED STEEL MEASURING TIPS.

TYPE	RANGE	READING	₹
MMC25 - P1	0 - 25 mm	0.01 mm	5430
MMC50 - P1	25 - 50 mm	0.01 mm	7060
MMC75 - P1	50 - 75 mm	0.01 mm	8520
MMC100 - P1	75 - 100 mm	0.01 mm	10650

TYPE	RANGE	READING	₹
INC1 - P1	0 - 1 inch	0.001 inch	5430
INC2 - P1	1 - 2 inch	0.001 inch	7060
INC3 - P1	2 - 3 inch	0.001 inch	8520
INC4 - P1	3 - 4 inch	0.001 inch	10650

5) POINT TYPE : 30° HARDENED STEEL MEASURING TIPS.

TYPE	RANGE	READING	₹
MMC25 - P2	0 - 25 mm	0.01 mm	5030
MMC50 - P2	25 - 50 mm	0.01 mm	6290
MMC75 - P2	50 - 75 mm	0.01 mm	7140
MMC100 - P2	75 - 100 mm	0.01 mm	8375

TYPE	RANGE	READING	₹
INC1 - P2	0 - 1 inch	0.001 inch	5030
INC2 - P2	1 - 2 inch	0.001 inch	6290
INC3 - P2	2 - 3 inch	0.001 inch	7140
INC4 - P2	3 - 4 inch	0.001 inch	8375

6) SPLINE TYPE : Ø3 mm X L 8 mm CARBIDE MEASURING FACES.

TYPE	RANGE	READING	₹
MMC25 - S3	0 - 25 mm	0.01 mm	6030
MMC50 - S3	25 - 50 mm	0.01 mm	7550
MMC75 - S3	50 - 75 mm	0.01 mm	8910
MMC100 - S3	75 - 100 mm	0.01 mm	9450

TYPE	RANGE	READING	₹
INC1 - S3	0 - 1 inch	0.001 inch	6030
INC2 - S3	1 - 2 inch	0.001 inch	7550
INC3 - S3	2 - 3 inch	0.001 inch	8910
INC4 - S3	3 - 4 inch	0.001 inch	9450

7) SPLINE TYPE : Ø2 mm X L 5 mm CARBIDE MEASURING FACES.

TYPE	RANGE	READING	₹
MMC25 - S2	0 - 25 mm	0.01 mm	6030
MMC50 - S2	25 - 50 mm	0.01 mm	7550
MMC75 - S2	50 - 75 mm	0.01 mm	8910
MMC100 - S2	75 - 100 mm	0.01 mm	9450

TYPE	RANGE	READING	₹
INC1 - S2	0 - 1 inch	0.001 inch	6030
INC2 - S2	1 - 2 inch	0.001 inch	7550
INC3 - S2	2 - 3 inch	0.001 inch	8910
INC4 - S2	3 - 4 inch	0.001 inch	9450

NOTE: 1) CERTIFICATE OF INSPECTION IS SUPPLIED WITH EACH MICROMETER, TRACEABLE TO NATIONAL LENGTH STANDARDS.
2) PRICES FOR READINGS 0.001 mm & 0.0001 inch ON REQUEST.

8) BLADE MICROMETERS (BLADE THICKNESS 0.75 mm)

TYPE	RANGE	READING	₹
MMC25 - B	0 - 25 mm	0.01 mm	9160
MMC50 - B	25 - 50 mm	0.01 mm	9750
MMC75 - B	50 - 75 mm	0.01 mm	10070
MMC100 - B	75 - 100 mm	0.01 mm	11140
MMC125 - B	100 - 125 mm	0.010 mm	16180
MMC150 - B	125 - 150 mm	0.010 mm	18930
MMC175 - B	150 - 175 mm	0.010 mm	20670
MMC200 - B	175 - 200 mm	0.010 mm	22250

BLADE MICROMETERS (BLADE THICKNESS 0.75 mm)

TYPE	RANGE	READING	₹
INC1 - B	0 - 1 inch	0.001 inch	9160
INC2 - B	1 - 2 inch	0.001 inch	9750
INC3 - B	2 - 3 inch	0.001 inch	10070
INC4 - B	3 - 4 inch	0.001 inch	11140
INC5 - B	4 - 5 inch	0.001 inch	16180
INC6 - B	5 - 6 inch	0.001 inch	18930
INC7 - B	6 - 7 inch	0.001 inch	20670
INC8 - B	7 - 8 inch	0.001 inch	22250

BLADE MICROMETERS (BLADE THICKNESS 0.4 mm)

TYPE	RANGE	READING	₹
MMC25 - BA	0 - 25 mm	0.01 mm	10520
MMC50 - BA	25 - 50 mm	0.01 mm	11200
MMC75 - BA	50 - 75 mm	0.01 mm	11570
MMC100 - BA	75 - 100 mm	0.01 mm	12800
MMC125 - BA	100 - 125 mm	0.01 mm	20720
MMC150 - BA	125 - 150 mm	0.01 mm	24250
MMC175 - BA	150 - 175 mm	0.01 mm	26480
MMC200 - BA	175 - 200 mm	0.01 mm	28490

TYPE	RANGE	READING	₹
INC1 - BA	0 - 1 inch	0.001 inch	10520
INC2 - BA	1 - 2 inch	0.001 inch	11200
INC5 - BA	2 - 3 inch	0.001 inch	11570
INC4 - BA	3 - 4 inch	0.001 inch	12800
INC5 - BA	4 - 5 inch	0.001 inch	20720
INC6 - BA	5 - 6 inch	0.001 inch	24250
INC7 - BA	6 - 7 inch	0.001 inch	26480
INC8 - BA	7 - 8 inch	0.001 inch	28490

SETTING GAUGES FOR EXTERNAL MICROMETERS

PART NO.	SIZE	UNIT PRICE ₹	PART NO.	SIZE	UNIT PRICE ₹
MM0200C066000BF00F	25.0 mm	480	MI0200C069000BF00F	1.0 inch	590
MM0300C091000BF00F	50.0 mm	550	MI0300C094000BF00F	2.0 inch	620
MM0400C116000BF00F	75.0 mm	590	MI0400C119000BF00F	3.0 inch	660
MM0500C141000BF00F	100.0 mm	620	MI0500C144000BF00F	4.0 inch	730
MM0600C167000BF00F	125.0 mm	760	MI0600C170000BF00F	5.0 inch	790
MM0700C193000BF00F	150.0 mm	830	MI0700C196000BF00F	6.0 inch	860
MM0800C219000BF00F	175.0 mm	890	MI0700C196000BF00F	7.0 inch	930
MM0900C245000BF00F	200.0 mm	930	MI0900C262000BF00F	8.0 inch	1000
MM0900C246000BF00F	225.0 mm	1030	MI0900C263000BF00F	9.0 inch	1100
MM0900C247000BF00F	250.0 mm	1100	MI0900C264000BF00F	10.0 inch	1170
MM0900C248000BF00F	275.0 mm	1170	MI0900C265000BF00F	11.0 inch	1240

MECHANICAL MICROMETERS SPARES PRICE LIST

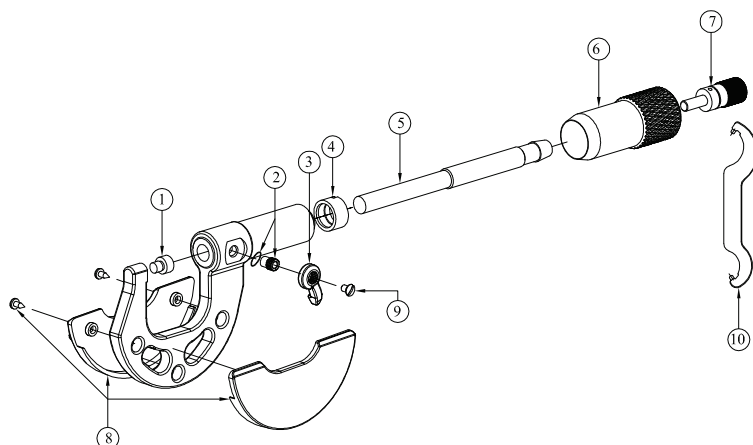

REF. NO.	DESCRIPTION
1	Anvil
2	Pressure Screw M4 with washer
3	Metal Locking Lever
4	Collet Lock Nut
5	Spindle
6	Thimble Marked
7	Ratchet Knob
8	Handle Shell Set
9	Raised CSK Screw
10	Spanner

MECHANICAL MICROMETERS SPARES

PART NO.	PART DESCRIPTION	UNIT PRICE ₹	USED ON
M00000C459000D04GF	Finish Spindle mm ("C"series)	575	All micrometers MMC25 to MMC200
M00000C476000D04GF	Finish Spindle inch ("C"series)	575	All micrometers INC1 to INC8
MM0000C0490000D04F	Thimble Marked mm ("C"series)	230	All micrometers MMC25 to MMC200
MI0000C1020000D04F	Thimble Marked inch ("C"series)	230	All micrometers INC1 to INC8
M00000C020000000BF	Pressure Screw M4 x 0.7	15	All micrometers MMC25 to MMC200, INC1 to INI8
M00100C0210000000F	Metalic Locking Lever (0-25mm)	10	All micrometers MMC25 to MMC200, INC1 to INI8 & MMI0-100 to MMI400-500, INI0-4 to INI16-20"
M00000C0150000000F	Raised CSK Screw M2.5	5	All micrometers MMC25 to MMC200, INC1 to INI8 & MMI0-100 to MMI400-500, INI0-4 to INI16-20"
I00000C0240000000F	Ratchet Knob	125	All micrometers Up to 1000mm
M00000C0110000000F	Spanner	25	All micrometers Up to 500
M00000C521000B000F	Wave Washer	5	All micrometers Up to 500

DIGITAL MICROMETERS SPARES

PART NO.	PART DESCRIPTION	UNIT PRICE ₹	USED ON
IM010150040000000F	Electronic module IP65 0-25 mm	3340	DMM25
IM020150040000000F	Electronic module IP65 25-50 mm	3800	DMM50
IM030150040000000F	Electronic module IP65 50-75 mm	4200	DMM75
IM040150040000000F	Electronic module IP65 75-100 mm	4800	DMM100
IM050150040000000F	Electronic module IP65 100-125 mm	5300	DMM125
IM060150040000000F	Electronic module IP65 125-150 mm	5600	DMM150
IM070150040000000F	Electronic module IP65 150-175 mm	5900	DMM175
IM080150040000000F	Electronic module IP65 175-200 mm	6200	DMM200
IM0101SK040000000F	Electronic module 0-25 mm (SINGLE KEY)	2600	DMME25
IM0201SK040000000F	Electronic module IP65 25-50 mm (SINGLE KEY)	2900	DMME50
IM0301SK040000000F	Electronic module IP65 50-75 mm (SINGLE KEY)	3200	DMME75
IM0401SK040000000F	Electronic module IP65 75-100 mm (SINGLE KEY)	3400	DMME100
IM0501SK040000000F	Electronic module IP65 100-125 mm (SINGLE KEY)	3600	DMME125
IM0601SK040000000F	Electronic module IP65 125-150 mm (SINGLE KEY)	3800	DMME150
IM0701SK040000000F	Electronic module IP65 150-175 mm (SINGLE KEY)	4100	DMME175
IM0801SK040000000F	Electronic module IP65 175-200 mm (SINGLE KEY)	4300	DMME200
I00000C00600000000F	Battery cap with washer	25	All Digital Micrometer

TERMS AND CONDITIONS (for products)

1. PRICE : Ex. Works, Pune.
2. PACKING & FORWARDING : Extra @ 3%
3. GST : Extra as applicable.
4. PAYMENT : 25% Advance alongwith order and balance against Proforma Invoice.
5. DESPATCH : Courier Service
6. FREIGHT : Extra at Actual
7. ANY OTHER LEVY : Extra to your account
8. This price list is subject to alteration without any notice & cancels all our previous price lists.

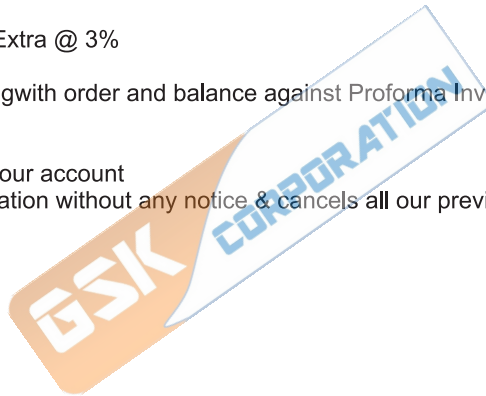

SPECIAL DIGITAL MICROMETERS

INTERCHANGEABLE BALL ANVIL / SPINDLE TIP

Ball Diameter mm	Gear Module	Dia Pitch	₹
1	0.6-0.65	45	5540
1.5	0.9-1.0	26-28	5340
2	1.25	22	5160
2.5	1.5	17	5160
3	1.75	15	4980
3.5	2	13	4980
4	2.25	11	4790
4.5	2.5	10	4790
5	2.75	9	4570
6	3.5	7	4570

DIGITAL EXTERNAL MICROMETERS WITHOUT DATA OUTPUT

TYPE	RANGE	READING	₹
DMM25	0 - 25 mm	0.001 mm / 0.00005 inch	7980
DMM50	25 - 50 mm	0.001 mm / 0.00005 inch	10405
DMM75	50 - 75 mm	0.001 mm / 0.00005 inch	12320
DMM100	75 - 100 mm	0.001 mm / 0.00005 inch	14250
DMM125	100 - 125 mm	0.001 mm / 0.00005 inch	15710
DMM150	125 - 150 mm	0.001 mm / 0.00005 inch	17625
DMM175	150 - 175 mm	0.001 mm / 0.00005 inch	18870
DMM200	175 - 200 mm	0.001 mm / 0.00005 inch	20755
DMM225	200 - 225 mm	0.001 mm / 0.00005 inch	25600
DMM250	225 - 250 mm	0.001 mm / 0.00005 inch	27670
DMM275	250 - 275 mm	0.001 mm / 0.00005 inch	29750
DMM300	275 - 300 mm	0.001 mm / 0.00005 inch	31830

DIGITAL EXTERNAL MICROMETERS WITH DATA OUTPUT

TYPE	RANGE	READING	₹
DMM25 - 1	0 - 25 mm	0.001 mm / 0.00005 inch	9865
DMM50 - 1	25 - 50 mm	0.001 mm / 0.00005 inch	12560
DMM75 - 1	50 - 75 mm	0.001 mm / 0.00005 inch	16075
DMM100 - 1	75 - 100 mm	0.001 mm / 0.00005 inch	18065
	Data Cable P1505		6000

VALUE LINE DIGITAL EXTERNAL MICROMETER

TYPE	RANGE	READING	₹
DMME25	0-25 mm	0.001 mm	5820
DMME50	25-50 mm	0.001 mm	6980
DMME75	50-75 mm	0.001 mm	7860
DMME100	75-100 mm	0.001 mm	8730
DMME125	100-125 mm	0.001 mm	10200
DMME150	125-150 mm	0.001 mm	11000
DMME175	150-175 mm	0.001 mm	11950
DMME200	175-200 mm	0.001 mm	13210
DMME225	200 - 225 mm	0.001 mm	18400
DMME250	225 - 250 mm	0.001 mm	20250
DMME275	250 - 275 mm	0.001 mm	22100
DMME300	275 - 300 mm	0.001 mm	24300

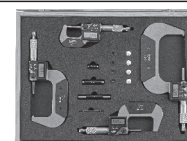
SET OF DIGITAL MICROMETERS

1) A SET OF FOUR DIGITAL MICROMETERS IN ONE WOODEN BOX

TYPE	RANGE	READING	₹
4DMM100	0 - 100 mm	0.001 mm / 0.00005 inch	45550

NOTE: CERTIFICATE OF INSPECTION IS SUPPLIED WITH EACH MICROMETER, TRACEABLE TO NATIONAL LENGTH STANDARDS.

SPECIAL DIGITAL MICROMETERS

DIGITAL BLADE MICROMETER

TYPE	RANGE	READING	₹
DMM25-B	0-25	0.001 mm/0.00005"	22670
DMM50-B	25-50	0.001 mm/0.00005"	24070
DMM75-B	50-75	0.001 mm/0.00005"	25470
DMM100-B	75-100	0.001 mm/0.00005"	27370

DIGITAL NON ROTATING DISC MICROMETER

TYPE	RANGE	READING	₹
DMM25-ND	0-25	0.001 mm/0.00005"	19550
DMM50-ND	25-50	0.001 mm/0.00005"	22260
DMM75-ND	50-75	0.001 mm/0.00005"	23940
DMM100-ND	75-100	0.001 mm/0.00005"	26460
DMM125-ND	100-125	0.001 mm/0.00005"	29310
DMM150-ND	125-150	0.001 mm/0.00005"	31920
DMM175-ND	150-175	0.001 mm/0.00005"	34720
DMM200-ND	175-200	0.001 mm/0.00005"	37610

DIGITAL POINT MICROMETER 30° ANVIL

TYPE	RANGE	READING	₹
DMM25-P2	0-25	0.001 mm/0.00005"	17220
DMM50-P2	25-50	0.001 mm/0.00005"	18400
DMM75-P2	50-75	0.001 mm/0.00005"	19560
DMM100-P2	75-100	0.001 mm/0.00005"	20750

DIGITAL POINT MICROMETER 15° ANVIL

TYPE	RANGE	READING	₹
DMM25-P1	0-25	0.001 mm/0.00005"	17220
DMM50-P1	25-50	0.001 mm/0.00005"	18400
DMM75-P1	50-75	0.001 mm/0.00005"	19560
DMM100-P1	75-100	0.001 mm/0.00005"	20750

DIGITAL TUBE MICROMETER BOTH MEASURING FACES SPHERICAL

TYPE	RANGE	READING	₹
DMM25-T2	0-25	0.001 mm/0.00005"	17360

DIGITAL TUBE MICROMETER ONE MEASURING FACES SPHERICAL

TYPE	RANGE	READING	₹
DMM25-T1	0-25	0.001 mm/0.00005"	14990

DIGITAL DEPTH MICROMETER

TYPE	RANGE	READING	₹
DMM150	0-150	0.001 mm / 0.00005"	21060

DIGITAL GEAR MICROMETER

TYPE	RANGE	READING	₹
DMM25-G	0-25	0.001 mm / 0.00005"	17480
DMM50-G	25-50	0.001 mm / 0.00005"	18250
DMM75-G	50-75	0.001 mm / 0.00005"	19030
DMM100-G	75-100	0.001 mm / 0.00005"	19800

DIGITAL SCREW THREAD MICROMETER

TYPE	RANGE	READING	₹
DMM25 - ST	0-25 mm	0.001 mm / 0.00005 inch	19900
DMM50 - ST	25-50 mm	0.001 mm / 0.00005 inch	20900
DMM75 - ST	50-75 mm	0.001 mm / 0.00005 inch	21000
DMM100 - ST	75-100 mm	0.001 mm / 0.00005 inch	22200

CALIBRATION CHARGES

A. PARALLEL THREAD GAUGES - (STANDARD GAUGES)

PARTICULARS	SIZE RANGE UP TO 20 mm UP TO 3/4" ₹	SIZE RANGE 21 mm TO 40 mm 13/16" TO 1.1/2" ₹	SIZE RANGE 41 mm TO 100 mm 1.9/16" TO 4" ₹	SIZE RANGE 101 mm TO 200 mm 4.1/8" TO 8" ₹
THREAD PLUG	270	410	630	950
THREAD RING GO OR NOT GO	360	700	1220	2140

PARTICULARS	SIZE RANGE 201 mm TO 250 mm 8.1/4" & 10" ₹	SIZE RANGE 251 mm TO 300 mm 10.1/4" & 12" ₹	SIZE RANGE 301 mm TO 350 mm 12.1/4" & 14" ₹	SIZE RANGE 351 mm TO 400 mm 14.1/4" & 16" ₹
S/E THREAD PLUG	970	1300	1840	2590
THREAD RING GO OR NOT GO	2810	3450	4540	6050

B. TAPER THREAD GAUGES

PARTICULARS	SIZE RANGE UP TO 3/4" ₹	SIZE RANGE 1" TO 1.1/2" ₹	SIZE RANGE 2" TO 4" ₹	SIZE RANGE 5" TO 8" ₹
TAPER THREAD PLUG	650	820	1520	1900
TAPER THREAD RING	1100	1720	2250	2730

C. PARALLEL PLAIN GAUGES

PARTICULARS	SIZE RANGE UP TO 20 mm ₹	SIZE RANGE 21 mm TO 40 mm ₹	SIZE RANGE 41 mm TO 100 mm ₹	SIZE RANGE 101 mm TO 200 mm ₹
D/E PLAIN PLUG GO AND NOT GO	160	250	380	570
PLAIN RING GO OR NOT GO	270	410	680	1030

PARTICULARS	SIZE RANGE 201 mm & 250 mm ₹	SIZE RANGE 251 mm TO 300 mm ₹	SIZE RANGE 301 mm TO 350 mm ₹	SIZE RANGE 351 mm TO 400 mm ₹
S/E PLAIN PLUG GO OR NOT GO	810	1030	1300	1620
PLAIN RING GO OR NOT GO	1510	1940	2700	3460

D. TAPER PLAIN GAUGES

PARTICULARS	SIZE RANGE UP TO 20 mm ₹	SIZE RANGE 21 mm TO 40 mm ₹	SIZE RANGE 41 mm TO 60 mm ₹	SIZE RANGE 61 mm TO 100 mm ₹
TAPER PLAIN PLUG	390	570	920	1140
TAPER PLAIN RING	670	1040	1340	-

PARTICULARS	SIZE RANGE 101 mm & 250 mm ₹	SIZE RANGE 201 mm TO 250 mm ₹	SIZE RANGE 251 mm TO 300 mm ₹	
TAPER PLAIN PLUG	1500	1620	1890	
TAPER PLAIN RING	-	-	-	

NOTES :

- 1 Environmental condition maintained during calibration : 20 °C ± 1 °C and RH 50 ± 10%.
- 2 Calibration Laboratory is equipped with an extensive range of measuring instruments in the field of length measurement.
- 3 Measuring equipment are traceable to National / International Length Standards.
- 4 **Calibration services with NABL accreditation (ISO/IEC 17025 : 2017(E)) are also provided on request.**
- 5 Calibration of special Thread Gauges (ACME, TRAPEZOIDAL, BUTTRESS, ROUND THREAD, TAPER ABOVE 8", etc.) on request.

EXTERNAL MICROMETERS

SIZE RANGE	READING 0.010 mm (0.001 inch) ₹	READING 0.001 mm (0.0001 inch) ₹	SIZE RANGE	READING 0.010 mm (0.001 inch) ₹	READING 0.001 mm (0.0001 inch) ₹
0 - 25 mm 0 - 1 inch	290	360	125 - 150 mm 5 inch - 6 inch	670	800
25 - 50 mm 1 inch - 2 inch	380	450	150 - 175 mm 6 inch - 7 inch	930	1110
50 - 75 mm 2 inch - 3 inch	460	560	175 - 200 mm 7 inch - 8 inch	1200	1430
75 - 100 mm 3 inch - 4 inch	550	650	200 - 300 mm 8 inch - 12 inch	2970	3440
100 - 125 mm 4 inch - 5 inch	600	720	300 - 400 mm 12 inch - 20 inch	3130 12 inch - 16 inch	3560
			400 - 500 mm 16 inch - 20 inch	3130	3560

CALIBRATION CHARGES FOR DIGITAL EXTERNAL MICROMETERS

RANGE	₹	RANGE	₹
0 - 25 mm (0.001mm)	410	125 - 150 mm (0.001mm)	950
25 - 50 mm (0.001mm)	510	150 - 175 mm (0.001mm)	1210
50 - 75 mm (0.001mm)	600	175 - 200 mm (0.001mm)	1570
75 - 100 mm (0.001mm)	760	200 - 300 mm (0.001mm)	3560
100 - 125 mm (0.001mm)	880	300 - 400 mm (0.001mm)	3780
		400 - 500 mm (0.001mm)	3780

NOTES :

- 1 Environmental condition maintained during calibration : 20°C ± 1°C and RH 50 ± 10%.
- 2 Calibration Laboratory is equipped with an extensive range of measuring instruments in the field of length measurement.
- 3 Measuring equipments are traceable to National / International Length Standards.
- 4 Calibration services with NABL accreditation (ISO/IEC 17025 : 2005(E)) are also provided on request.
- 5 Calibration of special Micrometers on request.

PRODUCTS RANGE

PRODUCT RANGE	
THREAD PLUGS	: 1 mm TO 450 mm
TAPER THREAD PLUGS	: 1/16 inch TO 17 inch (TAPER 1:16)
THREAD RINGS	: 1 mm TO 500 mm
TAPER THREAD RINGS	: 1/16 inch TO 16 inch (TAPER 1:16)
FOR SPECIAL THREAD PLUGS AND RINGS INCLUDING ACME, TRAPEZOIDAL, BUTTRESS, ROUND THREAD, ETC PRICES WILL BE FURNISHED AGAINST SPECIFIC ENQUIRIES.	
EXTERNAL MICROMETERS	: 0 TO 1000 mm READING 0.01 mm (READING 0.001 mm UP TO 150 mm) : 0 - 40 inch READING 0.001 inch (READING 0.0001" UP TO 6")
DIGITAL EXTERNAL MICROMETER	: 0 - 200 mm READING 0.001 mm : 0 - 8 inch READING 0.00005 inch
SPECIAL EXTERNAL MICROMETER	: TUBE TYPE, DISC TYPE, POINT TYPE, SPLINE TYPE & BLADE TYPE

TERMS AND CONDITIONS (for Services)

1. GST: Extra as applicable
2. PAYMENT : 100% against Proforma Invoice.
3. DESPATCH : Courier Service
4. FREIGHT : Extra at Actual
5. ANY OTHER LEVY : Extra to your account
6. This price list is subject to alteration without any notice & cancels all our previous price lists.

BAKER GAUGES INDIA PRIVATE LIMITED

www.bakergauges.com

BMI DIVISION

CORPORATE OFFICE & FACTORY

33-1-2, NAGAR ROAD, PUNE - 411 014, INDIA



HIP DIVISION

HEAD OFFICE & FACTORY

37-40, NAGAR ROAD, PUNE - 411 014, INDIA

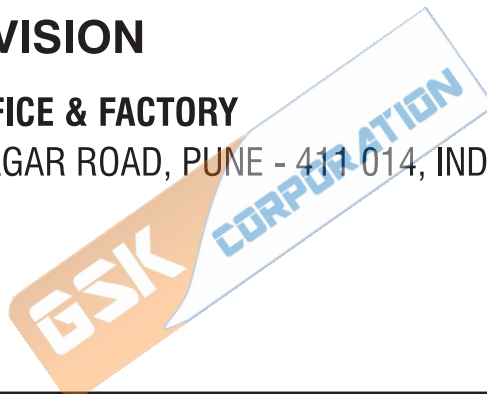

AN ISO 9001:2015 CERTIFIED COMPANY

DUE TO OUR CONTINUOUS ENDEAVOUR TO GIVE YOU THE BEST, THE MODELS, DESIGN AND SPECIFICATIONS ARE SUBJECT TO CHANGE WITHOUT PRIOR NOTICE.



Industrial Tools & Solutions Provider

Your Trusted Partner for Industrial Productivity & Performance

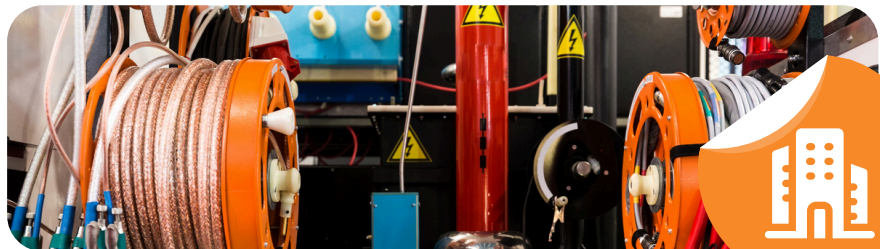

Presented by
Sachin Kothawade

+91 77419 75806

www.gskcut.com | www.gskcorporation.com

7 SHIVAM, RAMESHWAR NAGAR, NEAR SHUBHAM PARK, OPP SBI ATM,
KAMATWADE SHIVAR, MAHARASHTRA 422010
Email- gskcorporation.in@gmail.com



Who We Are

GSK Corporation is a leading provider of Industrial Tools, Abrasive Solutions, Cutting Tools, Packaging Machinery, and MRO Supplies, delivering high-quality products that empower industries to work smarter and faster.



We aim to become the most trusted and preferred partner for businesses by ensuring reliable service, genuine products, rapid delivery, and expert support. From small workshops to large industries, we provide solutions that improve productivity and enhance operational safety.

A Trusted Industrial Tools Partner

With years of experience and a diverse product portfolio, GSK Corporation stands as a one-stop solution for all industrial consumables and equipment.

- ✓ Premium quality products
- ✓ Best pricing & bulk supply
- ✓ Fast & reliable delivery
- ✓ Expert support after sales

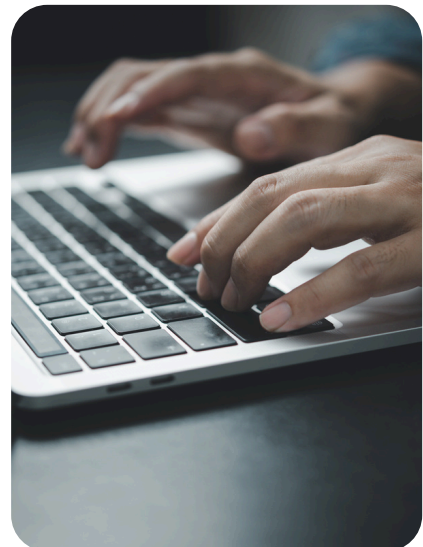

PRODUCT CATEGORIES



HAND TOOLS



FASTENERS



BEARINGS

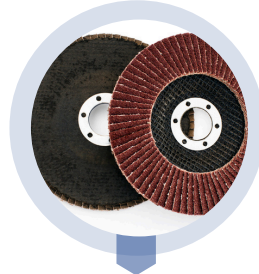

ABRASIVE DISC



MACHINE ACCESSORIES

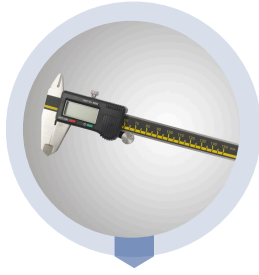

DIGITAL VERNIER'S



PNEUMATIC TOOLS



CUTTING TOOLS



MEASURING TOOLS



VALVES TOOLS



SAFETY TOOLS



POWER TOOLS

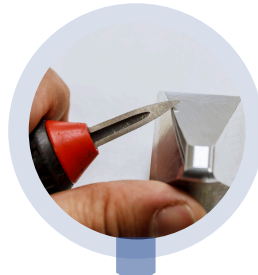

DEBURRING TOOL



WELDING ACCESSORIES



HELICOILS



HAND GLOVES

And we have many more industrial tools and solutions available to meet every industry need — with continuous product expansion to serve you better.”



Why Choose Us



At GSK Corporation, we deliver high-quality industrial tools and consumables designed for superior performance and durability. With a strong distribution network, competitive pricing, and trusted brand partners, we ensure faster delivery and reliable supply for all your business needs.



"We focus on precision, product reliability, and timely delivery – ensuring your operations never stop."

Simple, Effective, and Affordable

We offer a wide range of industrial tools that provide exceptional value without compromising on quality. Whether you need abrasives, power tools, or safety solutions, our experienced team is always ready to guide you with tailored product recommendations and after-sales support that helps you work smarter and grow faster



Results-Driven Product Quality



Customized Industrial Supply Solutions



Experienced & Knowledgeable Team



Full-Service Support for Business Growth





Let's Work Together

At GSK Corporation, we believe in building long-term partnerships with businesses by delivering reliable industrial tools and exceptional service. Whether you're a manufacturer, distributor, or workshop, our dedicated team ensures that you get the right products at the right time – helping you increase productivity and reduce downtime. Let's collaborate to drive better performance, fast delivery, and smart solutions for your operations.



Email- gskcorporation.in@gmail.com



**Ready to Take
Your Business
Online?**



+91 77419 75806

www.gskcut.com | www.gskcorporation.com

Presented by
Sachin Kothawade

7 SHIVAM, RAMESHWAR NAGAR, NEAR SHUBHAM PARK, OPP SBI ATM,
KAMATWADE SHIVAR, MAHARASHTRA 422010

Email- gskcorporation.in@gmail.com