



# TOTEM



High Performance Cutting Tools

## PRICE LIST

EFFECTIVE 08.01.2024



## DIES & DIE NUTS



Forbes & Company Limited

# Hints on use of circular dies

- Always ensure the die is presented to the bolt squarely, and is concentric, if this is not correct the die will not cut evenly on all lands.
- When adjusting a split die, try to avoid opening it out excessively, as it tends to rubbing or breakage.
- When closing in, do not apply all the pressure on one position but keep it even. Dies will cut satisfactorily provided adjustment is kept in the range of approximately 0.4 mm
- Thread tearing and teeth chipping are due to incorrect sharpening of lands or due to causing the die to hit the shoulder.
- Before starting a die always chamfer the end of the bolt at around 45 to allow the die to start cutting gently, failure to do this throws a sudden jerk on to the cutting edge, causing chipping.
- The size of the bolt to be threaded should be basic size, as an oversize material will put an extra load on the die whilst cutting.
- Whenever dies are used on machine it is recommended to use ground thread dies.
- When the die is to be used on machine without lead screw feed, ensure that the die will be able to advance in to the hole freely. This ensures that it will cut its own correct pitch.
- Efficient threading using die has its optimum speed. Always start with lower speeds and increase slowly if work permits.
- First class threading can only be done with copious supply of proper lubricant. Use of lubricant is as important as its choice. Choose suitable lubricant.

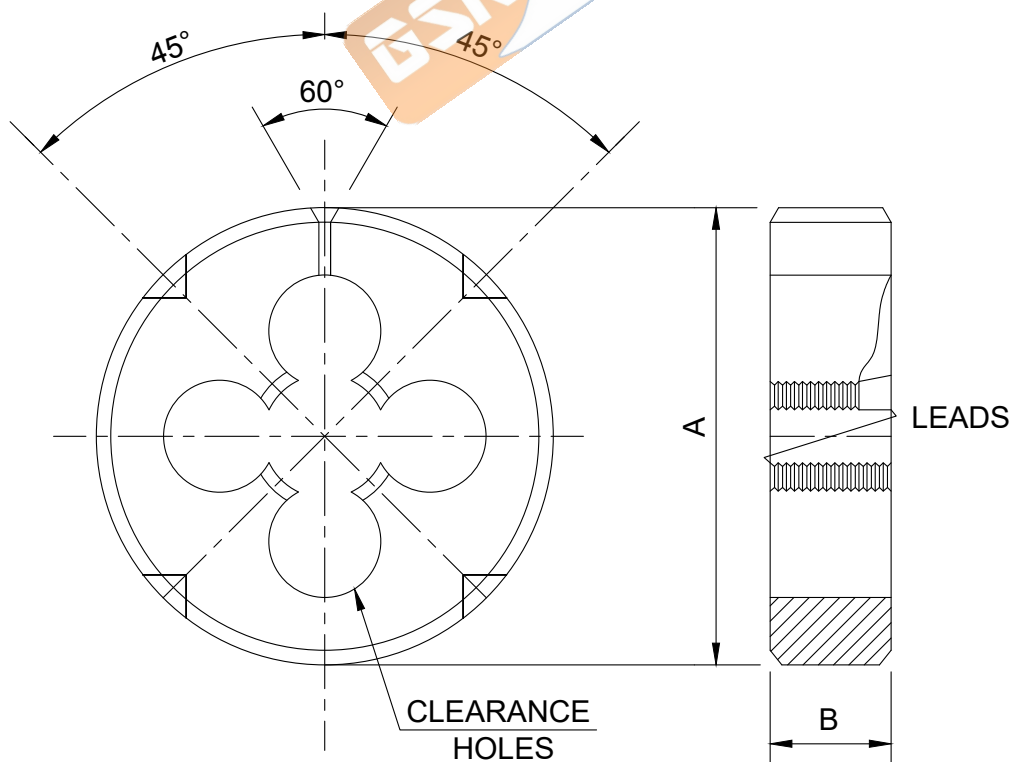

# High Speed Steel Cut Thread Circular Split Dies



ALL RATES ARE IN RUPEES PER PIECE (Excl. of GST)

OD INCH	SIZE INCH	Each (₹)								
		BSW	BSF	UNF/ UNC	BSB	BSCYCLE	ME	BSP	BSCON	BA
13/16"	0	-	-		-	-	-	-	-	393
	1	-	-		-	-	-	-	-	393
	2	-	-		-	-	-	-	-	393
	3	-	-	449	-	-	-	-	-	393
	4	-	-	449	-	-	-	-	-	393
	5	-	-	449	-	-	-	-	-	393
	6	-	-	449	-	-	-	-	-	393
	7	-	-		-	-	-	-	-	449
	8	-	-	449	-	-	-	-	-	449
	9	-	-		-	-	-	-	-	579
	10	-	-	449	-	-	-	-	-	579
	11	-	-		-	-	-	-	-	579
	12	-	-	449	-	-	-	-	-	579
	1/16	579	-		-	-	-	-	-	-
	3/32	449	-		-	-	-	-	-	-
	1/8	393	-		-	-	393	-	-	-
	5/32	393	-		-	-	393	-	-	-
	3/16	393	393		-	-	393	-	-	-
	7/32	393	393		-	-	393	-	-	-
	1/4	393	393	393	393	-	393	-	393	-
1"	1/8					-		559	-	-
	1/4	559	559	559	559	559	559	-	-	-
	9/32	559	559				559	-	-	-
	5/16	559	559	559	559	559	559	-	-	-
	3/8	559	559	559	559	559	559	-	-	-
	0.308 X 30				-	559		-	-	-

ALL RATES ARE IN RUPEES PER PIECE (Excl. of GST)

OD INCH	SIZE INCH	Each (₹)					
		BSW	BSF	UNF	UNC	BSP	BSCON
1.1/2"	1/4	-	-	-	-	931	
	3/8	-	-	-	-	931	
	7/16	931	931	931	931		
	1/2	931	931	931	931	931	931
	9/16	931	931	931	931		
	5/8	931	931	931	931		931
	11/16	931					
2"	3/4	931	931	931	931		931
	1/2					1483	
	5/8					1483	
	3/4					1483	
	7/8	1483	1483	1483	1483	1483	
	1"	1483	1483	1483	1483	1483	
	2.1/4"	7/8				1885	
2.1/2"	1.1/8	1958	1958	1958	1958		
	1.1/4	1958	1958	1958	1958		
	1.1/8					3079	
3"	1.1/4	3079				3079	
	1.3/8	3079	3079	3079	3079		
	1.1/2	3079	3079	3079	3079		
	1.1/4					4347	
4"	1.1/2	4347	4347	4347	4347		4347
	1.3/8					6065	
	1.1/2					6065	
	1.3/4	6065	6065	6065	6065	6065	
	2"	6065	6065	6065	6065	6065	

MOQ Matrix	
OD	QTY
2.1/4"	5
2.1/2"	5
3"	3
4"	3

# High Speed Steel Cut Thread Circular Split Dies



ALL RATES ARE IN RUPEES PER PIECE (Excl. of GST)

OD INCH	SIZE MM	Each ₹	OD INCH	SIZE MM	Each ₹	OD INCH	SIZE MM	Each ₹
13/16"	1.6 X 0.35	579	1"	6 X 0.5	598	1.1/2"	11 X 1.0	931
	2 X 0.4	449		6 X 0.75	598		11 X 1.5	931
	2.2 X 0.45	449		6 X 1	559		12 X 1	931
	2.3 X 0.4	449		7 X 0.75	598		12 X 1.25	931
	2.5 X 0.45	449		7 X 1	559		12 X 1.5	931
	2.6 X 0.45	449		8 X 0.75	598		12 X 1.75	931
	3 X 0.35, 0.60	449		8 X 1.0	598		14 X 1	931
	3 X 0.5	393		8 X 1.25	559		14 X 1.25	931
	3.5 X 0.6	393		9 X 0.75	598		14 X 1.5	931
	4 X 0.35, 0.50	449		9 X 1.0	598		14 X 2.0	931
	4 X 0.7	393		9 X 1.25	559		15 X 1.5	931
	4 X 0.75	449		10 X 0.5	598		16 X 1	931
	4.5 X 0.50	449		10 X 0.75	598		16 X 1.5	931
	4.5 X 0.75	449		10 X 1.25	598		16 X 2.0	931
	5 X 0.8	393		10 X 1.5	559		18 X 1.5	931
	5 X 0.9	449		-	-		18 X 2.5	931
	5.5 X 0.75	449		-	-		20 X 1.5	931
	5.5 X 0.5, 0.9	449		-	-		20 X 2.5	931
	6 X 0.5, 0.75	449		-	-		-	-
	6 X 1	393		-	-		-	-
	7 X 0.75	449		-	-		-	-
	7 X 1	449		-	-		-	-
2"	22 X 1.5	1483	2.1/4"	27 X 1.5, 3.0	1958	2.1/2"	34 X 1.5	3079
	22 X 2.5	1483		28 X 1.5	1958		35 X 1.5	3079
	24 X 1, 1.5, 3	1483		30 X 1.5, 3.5	1958		36 X 1.5	3079
	25 X 1.5	1483		32 X 1.5	1958		36 X 4.0	3079
	26 X 1.5	1483		33 X 1.5	1958		40 X 1.5	3079
	-	-		33 X 3.5	1958		-	-
3"	34 X 1.5	4347	4"	45 X 1.5	6065		-	-
	35 X 1.5	4347		46 X 1.5	6065		-	-
	36 X 1.5, 4.0	4347		48 X 1.5, 5.0	6065		-	-
	38 X 1.5	4347		50 X 1.5	6065		-	-
	39 X 4	4347		52 X 1.5	6065		-	-
	42 X 4.5	4347		55 X 1.5	6065		-	-
	45 X 1.5	4347		60 X 1.5	6065		-	-

ALL RATES ARE IN RUPEES PER PIECE (Excl. of GST)

OD INCH	SIZE INCH	Each (₹)								
		BSW	BSF	UNF/UNC	BSB	BSCYCLE	ME	BSP	BA	WF
13/16"	0	-	-	-	-	-	-	-	109	-
	1	-	-	-	-	-	-	-	109	-
	2	-	-	-	-	-	-	-	109	-
	3	-	-	109	-	-	-	-	109	-
	4	-	-	109	-	-	-	-	109	-
	5	-	-	109	-	-	-	-	109	-
	6	-	-	109	-	-	-	-	109	-
	7	-	-	-	-	-	-	-	157	-
	8	-	-	109	-	-	-	-	157	-
	9	-	-	-	-	-	-	-	186	-
	10	-	-	109	-	-	-	-	186	-
	11	-	-	-	-	-	-	-	265	-
	12	-	-	109	-	-	-	-	265	-
	11/64 X 40, 48	-	-	-	-	-	-	-	-	109
	13/64 X 24, 36	-	-	-	-	-	-	-	-	109
	3/16 X 28	-	-	-	-	-	-	-	-	109
	15/64 X 28, 40	-	-	-	-	-	-	-	-	109
	1/4X32	-	-	-	-	-	-	-	-	109
	1/16	265	-	-	-	-	-	-	-	-
	3/32	157	-	-	-	-	-	-	-	-
	1/8	109	-	-	-	-	109	-	-	-
	5/32	109	-	-	-	-	109	-	-	-
	3/16	109	109	-	-	109	109	-	-	-
	7/32	109	109	-	-	-	109	-	-	-
	1/4	109	109	109	109	109	109	-	-	-
1"	5/16 X 30, 40	-	-	-	-	-	-	-	-	171
	3/8 X 40	-	-	-	-	-	-	-	-	171
	1/8	-	-	-	-	-	-	171	-	-
	1/4	171	171	171	-	-	171	-	-	-
	9/32	171	171	-	-	-	171	-	-	-
	5/16	171	171	171	-	-	171	-	-	-
	3/8	171	171	171	-	-	171	-	-	-
	0.308 X 30	-	-	-	-	171	-	-	-	-

## Carbon Steel Cut Thread Circular Split Dies



ALL RATES ARE IN RUPEES PER PIECE (Excl. of GST)

OD INCH	SIZE INCH	Each (₹)							
		BSW	BSF	UNF / UNC	BSB	BSCYLE	BSP	BSCON	WF
1.1/2"	7/16 X 32, 40	-	-	-	-	-	-	-	361
	1/2 X 32, 40	-	-	-	-	-	-	-	361
	1/4	-	-	-	-	-	361	-	-
	3/8	-	-	-	-	-	361	-	-
	7/16	361	361	361	-	-	-	-	-
	1/2	361	361	361	-	-	361	361	-
	9/16	361	361	361	361	361	-	-	-
	5/8	361	361	361	-	-	-	361	-
	11/16	361	361	-	-	-	-	-	-
	3/4	361	361	361	-	-	-	361	-
2"	1/2	-	-	-	-	-	552	-	-
	5/8	-	-	-	-	-	552	-	-
	3/4	-	-	-	-	-	552	-	-
	7/8	552	552	552	-	-	552	-	-
	1"	552	552	552	-	-	552	552	-
2.1/4"	1.1/8	1117	1117	1117	-	-	-	-	-
	1.1/4	1117	1117	1117	-	-	-	-	-
2.1/2"	1.1/8	-	-	-	-	-	1575	-	-
	1.1/4	-	-	-	-	-	1575	-	-
	1.3/8	1575	1575	1575	-	-	-	-	-
	1.1/2	1575	1575	1575	-	-	-	-	-
3"	1.1/4	-	-	-	-	-	1776	1776	-
	1.1/2	1776	1776	1776	-	-	-	-	-
4"	1.3/8	-	-	-	-	-	2609	-	-
	1.1/2	-	-	-	-	-	2609	-	-
	1.3/4	2609	2609	2609	-	-	2609	-	-
	2"	2609	2609	2609	-	-	2609	-	-

MOQ Matrix	
OD	QTY
2.1/4"	5
2.1/2"	5
3"	3
4"	3

ALL RATES ARE IN RUPEES PER PIECE (Excl. of GST)

OD INCH	SIZE MM	Each ₹	OD INCH	SIZE MM	Each ₹	OD INCH	SIZE MM	Each ₹
13/16"	1.6 X 0.35	265	1"	6 X 0.5	171	1.1/2"	11 X 1.0, 1.5	361
	2 X 0.4	157		6 X 0.75	171		12 X 1, 1.25	361
	2.2 X 0.45	157		6 X 1	171		12 X 1.5	361
	2.3 X 0.4	157		7 X 0.75	171		12 X 1.75	361
	2.5 X 0.45	157		7 X 1	171		14 X 1, 1.25	361
	2.6 X 0.45	157		8 X 0.75	171		14 X 1.5	361
	3 X 0.5	109		8 X 1.0	171		14 X 2	361
	3.5 X 0.6	109		8 X 1.25	171		15 X 1.0	361
	4 X 0.35, 0.75	109		9 X 0.75	171		15 X 1.5	361
	4 X 0.7	109		9 X 1.0	171		16 X 1.0	361
	4.5 X 0.5	109		9 X 1.25	171		16 X 1.5	361
	4.5 X 0.75	109		10 X 0.75	171		16 X 2	361
	5 X 0.5, 0.75, 0.90	109		10 X 1.0	171		18 X 1.0	361
	5 X 0.8	109		10 X 1.25	171		18 X 1.5	361
	5.5 X 0.5, 0.90	109		10 X 1.5	171		18 X 2.0	361
	6 X 0.5, 0.75	109		-	-		18 X 2.5	361
	6 X 1	109		-	-		20 X 1.5	361
	7 X 0.75	109		-	-		20 X 2.5	361
	7 X 1	109		-	-		-	-
2"	20 X 1.5, 2.5	552	2.1/4"	27 X 1.5, 3.0	1117	2.1/2"	34 X 1.5	1575
	22 X 1.5, 2.5	552		28 X 1.5	1117		35 X 1.5	1575
	24 X 1.5	552		30 X 1.5, 3.5	1117		36 X 1.5	1575
	24 X 3	552		32 X 1.5	1117		36 X 4.0	1575
	25 X 1.5	552		33 X 1.5	1117		40 X 1.5	1575
	26 X 1.5	552		33 X 3.5	1117		-	-
3"	34 X 1.5	1776	4"	45 X 1.5	2609		-	-
	35 X 1.5	1776		46 X 1.5	2609		-	-
	36 X 1.5, 4.0	1776		48 X 1.5, 5.0	2609		-	-
	38 X 1.5	1776		50 X 1.5	2609		-	-
	39 X 4	1776		52 X 1.5	2609		-	-
	42 X 4.5	1776		55 X 1.5	2609		-	-
	45 X 1.5	1776		60 X 1.5	2609		-	-

MOQ Matrix	
OD	QTY
2.1/4"	5
2.1/2"	5
3"	3
4"	3

**High Speed Steel**

ALL RATES ARE IN RUPEES PER PIECE (Excl. of GST)

SIZE INCH	OD INCH					
	1" Each ₹	1.1/2" Each ₹	2" Each ₹	2.1/2" Each ₹	3" Each ₹	4" Each ₹
1/8"	872	930	-	-	-	-
1/4"	-	1040	-	-	-	-
3/8"	-	1221	1486	-	-	-
1/2"	-	-	1980	-	-	-
3/4"	-	-	2065	3658	-	-
1"	-	-	-	4129	4800	-
1.1/4"	-	-	-	-	5613	6743
1.1/2"	-	-	-	-	-	7208
2"	-	-	-	-	-	-

**Carbon Steel**

ALL RATES ARE IN RUPEES PER PIECE (Excl. of GST)

SIZE INCH	OD INCH					
	1" Each ₹	1.1/2" Each ₹	2" Each ₹	2.1/2" Each ₹	3" Each ₹	4" Each ₹
1/8"	471	599	-	-	-	-
1/4"	-	761	-	-	-	-
3/8"	-	797	1032	-	-	-
1/2"	-	-	1142	-	-	-
3/4"	-	-	1486	1885	-	-
1"	-	-	-	2082	2319	-
1.1/4"	-	-	-	-	2790	-
1.1/2"	-	-	-	-	-	3369
2"	-	-	-	-	-	3985

MOQ Matrix	
OD	QTY
1"	10
1.1/2"	10
2"	5
2.1/2"	5
3"	3
4"	3

### High Speed Steel Dies Nuts

ALL RATES ARE IN RUPEES PER PIECE (Excl. of GST)

Across Flat	BSW/BSF/UNC/UNF	BSP	METRIC MM	Each ₹
0.71	1/8" to 1/4"	-	3 to 6	366
0.82	5/16"	-	7 to 8	435
0.92	3/8"	1/8"	9 to 10	467
1.01	7/16"	-	11	640
1.10	1/2"	1/4"	12 to 13	710
1.30	9/16", 5/8"	3/8"	14 to 16	901
1.48	11/16", 3/4"	-	18 to 20	1072
1.67	7/8"	1/2", 5/8"	21 to 22	1455
2.05	1"	3/4"	24 to 26	2253

### Carbon Steel Dies Nuts

ALL RATES ARE IN RUPEES PER PIECE (Excl. of GST)

Across Flat	BSW/BSF/UNC/UNF	BSP	METRIC MM	Each ₹
0.71	1/8" to 1/4"	-	3 to 6	139
0.82	5/16"	-	7 to 8	150
0.92	3/8"	1/8"	9 to 10	165
1.01	7/16"	-	11	312
1.10	1/2"	1/4"	12 to 13	399
1.30	9/16", 5/8"	3/8"	14 to 16	435
1.48	11/16", 3/4"	-	18 to 20	484
1.67	7/8"	1/2", 5/8"	21 to 22	640
2.05	1"	3/4"	24 to 26	868

## High Speed Steel Ground Thread Dies



ALL RATES ARE IN RUPEES PER PIECE (Excl. of GST)

OD x THICKNESS	SIZE	Each ₹	OD x THICKNESS	SIZE	Each ₹
16 X 5	1.6 X 0.35	1061	30 X 11	10.0 X 1.00	1099
			-	10.0 X 1.25	1099
20 X 5	1.6 X 0.35	1061		10.0 X 1.50	1099
	2.0 X 0.40	821	-	-	
	2.5 X 0.45	821	38 X 10	12.0 X 1.00	1690
	2.6 X 0.45	821	-	12.0 X 1.25	1690
	3.0 X 0.50	714	-	12.0 X 1.5	1690
	4.0 X 0.70	714	-	14.0 X 1.00	1690
			-	14.0 X 1.25	1690
20 X 7	5.0 X 0.80	714	-	14.0 X 1.5	1690
	6.0 X 1.00	714	-	-	
			38 X 14	12.0 X 1.75	1690
25 X 9	7.0 X 1.00	1047	-	14.0 X 2.00	1690
	8.0 X 1.00	1099	-	-	
	8.0 X 1.25	1047	-	-	

\* All dies are in M2 Steel, we can quote for M35 Steel on request.

\* Gun nose dies can be offered on request.



### MOQ Matrix

OD	QTY
16X5	20
20X5	20
20X7	20
25X9	10
30X11	10
38X10	10
38X14	10

### Terms and conditions

1. This price list supercedes all our previous price lists.
2. Prices are exclusive of GST rate.
3. The prices quoted in this price list are the maximum retail prices and Dealers / Stockist are free to sell goods at prices lower than the prices fixed by the company."
4. Prices are subject to revision without prior notice.
5. For LH Thread - 35% add to std. price.
6. All legal proceeding are subjected to Mumbai jurisdiction.



**High Performance Cutting Tools**

## HEAD OFFICE

### Forbes & Company Limited

Forbes Building, Charanjit Rai Marg, Fort, Mumbai 400 001 | **Telephone:** +91 (0) 22 61358958 | **Email:** sales@forbes.co.in

## DIVISIONAL SALES OFFICES ADDRESS / PH. NO.

### AHMEDABAD

1<sup>st</sup> Floor, Pranjay Building,  
Opp. Bata Showroom, Near Times Of India,  
Ashram Road, Ahmedabad - 380009  
Telephone: +91 (0) 79 26587769, 079-26580741  
Fax: 079-26584618

### BENGALURU

Classic Building, 3<sup>rd</sup> Floor, 24 Richmond Road  
Bengaluru - 560025  
Telephone: +91 (0) 80 43230129  
Fax: +91 (0) 80 43230110

### CHENNAI

Catholic Centre, 1<sup>st</sup> Floor,  
108, Armenian Street,  
Chennai - 600001  
Telephone: +91 (0) 44 25389890/95,  
Fax: +91 (0) 44 25360872

### NEW DELHI

8F, 8<sup>th</sup> Floor, Vandana Building,  
Tolstoy Marg, New Delhi -110001  
Telephone: +91 (0) 11 43000120/107

### KOLKATA

222, Circular Mansion, 1<sup>st</sup> Floor,  
A.J.C. Bose Road,  
Kolkata-700 017  
Mobile: +91 (0) 70 91193999

### MUMBAI

Forbes Building, Charanjit Rai Marg,  
Fort, Mumbai 400 001  
Telephone: +91 (0) 22 69402500

### PUNE

H.No.1195/5, Bhosale Heights, 4<sup>th</sup> Floor,  
Opp. Deendayal Hospital, Fergusson College Road,  
Pune 411005  
Telephone: +91 (0) 20 48509111

### CHHATRAPATI SAMBHAJINAGAR

B 13, Waluj MIDC,  
Chhatrapati Sambhajanagar - 431133  
Telephone: +91 (0) 240 2553422



# Industrial Tools & Solutions Provider

Your Trusted Partner for Industrial Productivity & Performance

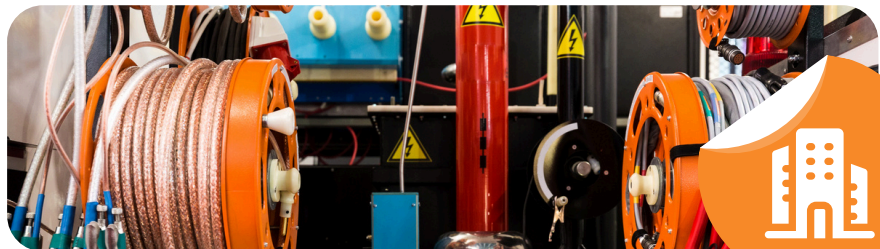

Presented by  
**Sachin Kothawade**

+91 77419 75806

[www.gskcut.com](http://www.gskcut.com) | [www.gskcorporation.com](http://www.gskcorporation.com)

7 SHIVAM, RAMESHWAR NAGAR, NEAR SHUBHAM PARK, OPP SBI ATM,  
KAMATWADE SHIVAR, MAHARASHTRA 422010  
Email- [gskcorporation.in@gmail.com](mailto:gskcorporation.in@gmail.com)



# Who We Are

GSK Corporation is a leading provider of Industrial Tools, Abrasive Solutions, Cutting Tools, Packaging Machinery, and MRO Supplies, delivering high-quality products that empower industries to work smarter and faster.



We aim to become the most trusted and preferred partner for businesses by ensuring reliable service, genuine products, rapid delivery, and expert support. From small workshops to large industries, we provide solutions that improve productivity and enhance operational safety.

## A Trusted Industrial Tools Partner

With years of experience and a diverse product portfolio, GSK Corporation stands as a one-stop solution for all industrial consumables and equipment.

- ✓ Premium quality products
- ✓ Best pricing & bulk supply
- ✓ Fast & reliable delivery
- ✓ Expert support after sales

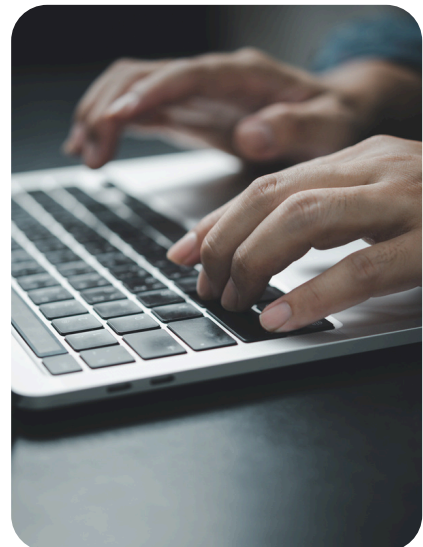

# PRODUCT CATEGORIES



HAND TOOLS



FASTENERS



BEARINGS

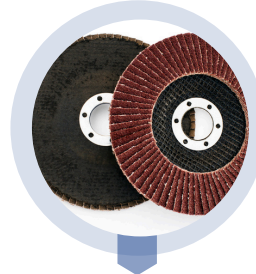

ABRASIVE DISC



MACHINE ACCESSORIES

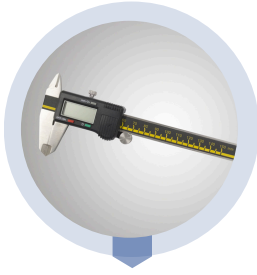

DIGITAL VERNIER'S



PNEUMATIC TOOLS



CUTTING TOOLS



MEASURING TOOLS

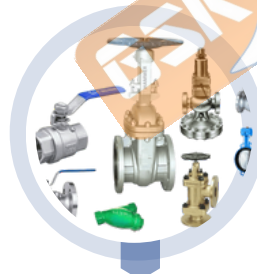

VALVES TOOLS



SAFETY TOOLS



POWER TOOLS

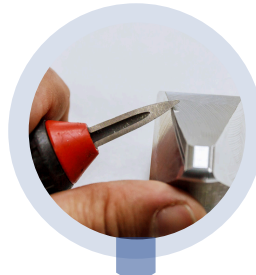

DEBURRING TOOL



WELDING ACCESSORIES



HELICOILS



HAND GLOVES

And we have many more industrial tools and solutions available to meet every industry need — with continuous product expansion to serve you better.”



# Why Choose Us



At GSK Corporation, we deliver high-quality industrial tools and consumables designed for superior performance and durability. With a strong distribution network, competitive pricing, and trusted brand partners, we ensure faster delivery and reliable supply for all your business needs.



"We focus on precision, product reliability, and timely delivery – ensuring your operations never stop."

## Simple, Effective, and Affordable

We offer a wide range of industrial tools that provide exceptional value without compromising on quality. Whether you need abrasives, power tools, or safety solutions, our experienced team is always ready to guide you with tailored product recommendations and after-sales support that helps you work smarter and grow faster



Results-Driven Product Quality



Customized Industrial Supply Solutions



Experienced & Knowledgeable Team



Full-Service Support for Business Growth





# Let's Work Together

At GSK Corporation, we believe in building long-term partnerships with businesses by delivering reliable industrial tools and exceptional service. Whether you're a manufacturer, distributor, or workshop, our dedicated team ensures that you get the right products at the right time – helping you increase productivity and reduce downtime.

Let's collaborate to drive better performance, fast delivery, and smart solutions for your operations.



**Ready to Take  
Your Business  
Online?**



+91 77419 75806

[www.gskcut.com](http://www.gskcut.com) | [www.gskcorporation.com](http://www.gskcorporation.com)

Presented by  
**Sachin Kothawade**

7 SHIVAM, RAMESHWAR NAGAR, NEAR SHUBHAM PARK, OPP SBI ATM,  
KAMATWADE SHIVAR, MAHARASHTRA 422010

Email- [gskcorporation.in@gmail.com](mailto:gskcorporation.in@gmail.com)